



**Argemí**<sup>®</sup>



**BARBACOES**  
BARBACOAS  
*BARBECUES*



LLARS DE FOC  
BARBACOES  
BIOMASSA

#### CA

Argemí és una empresa familiar de segona generació, de més de trenta anys d'experiència, que ha aconseguit consolidar-se i ser un referent en el disseny i la fabricació de producte propi en el sector de les llars de foc i barbacoes.

Fruit de la passió per la innovació, l'empresa reinventa el que ja existeix i dissenya nous models de barbacoes perquè pugueu compartir moments únics. Tot l'equip tècnic i de producció treballa per fer-ho possible, amb l'afany de millorar els nostres productes i evolucionar.



#### ES

Argemí es una empresa familiar de segunda generación, con más de treinta años de experiencia, que ha conseguido consolidarse y ser un referente en el diseño y la fabricación de producto propio en el sector de las chimeneas y barbacoas.

Fruto de la pasión por la innovación, la empresa reinventa lo que ya existe y diseña nuevos modelos de barbacoas para que ustedes puedan compartir momentos únicos. Todo el equipo técnico y de producción trabaja para hacerlo posible, con el afán de mejorar nuestros productos y evolucionar.



#### EN

*Argemí is a second-generation family company with over 30 years' experience, which has managed to become a reference in the design and manufacture of its own products in the fireplace and barbecue industry.*

*Its passion for innovation has led the company to reinvent what it already has, and to design new barbecue models for you to share even more unique moments. The whole of the technical and production team works to make this possible by improving and evolving its products.*



#### ASSESSORAMENT

Treballem per oferir la millor solució a les vostres necessitats. Disposem d'un ventall de possibilitats i materials per personalitzar cada model per a cada client i espai.

#### ASESORAMIENTO

Trabajamos para ofrecer la mejor solución a sus necesidades. Disponemos de un abanico de posibilidades y materiales para personalizar cada modelo para cada cliente y espacio.

#### ADVICE

*We work to offer the best solution to your needs. We have a wide range of possibilities and materials to customise each model for each customer and place.*



#### GAMMA ÀMPLIA DE PRODUCTES

Oferim una gamma de models tradicionals i rústics, així com models de línies actuals i minimalistes. Tots destaquen per la qualitat, funcionalitat i disseny.

#### GAMA AMPLIA DE PRODUCTOS

Ofrecemos una gama de modelos tradicionales y rústicos, así como modelos de líneas actuales y minimalistas. Todos destacan por su calidad, funcionalidad y diseño.

#### RANGE OF PRODUCTS

*We offer a range of traditional and rustic products as well as modern and minimalistic lines, all of which stand out for their quality, functionality and design.*



#### QUALITAT

Un procés de fabricació rigorós i la qualitat dels materials que utilitzem són dos trets imprescindibles per aguantar les altes temperatures del foc amb llenya i del carbó vegetal. El resultat és un producte amb acabats cuidats, de llarga durabilitat i gran resistència.

#### CALIDAD

Un proceso de fabricación riguroso y la calidad de los materiales que utilizamos son dos rasgos imprescindibles para aguantar las altas temperaturas del fuego con leña y del carbón vegetal. El resultado es un producto con acabados cuidados, de larga durabilidad y gran resistencia.

#### QUALITY

*A rigorous manufacturing process and the quality of the materials we use are two essential traits to withstand the high-temperature of wood and coal fires. The result is a long-lasting and very strong product with quality finishes.*



<b>MODERNES</b>	
DELTA RECTE	6
MONACO	8
LONDON	10
TENERIFE	12
CALELLA	14
BARCELONA	16
MILANO	18
BERLIN	20
MALTA	22
OLOT	24

<b>TRADICIONALS</b>	
ROMA	28
ARAN	30
ARAN LD/LI	30
ATENES	32
ATENES LD	32
OSLO	34
PATERNA	36
ESTIVELLA	38
NOGUERA	40
EMPORDÀ	42
GARROTXA	44
OSONA	46
MONTSEGRÌÀ TR	48
URGELL	50
URGELL FL/LD	52

<b>METÀL·LIQUES</b>	
SELVA	56
CANNES	56

<b>RÚSTIQUES</b>	
NIZA	60
TERRA ALTA	62
GARRIGUES	64
PALLARS	66
BERGUEDÀ	68
SEGARRA	70
MANAUS	72
QUITO	73
FORN	73
MALLORCA	74
MALLORCA LD/LI	74

Barbacoes de línies rectes d'estil modern, acabats "actuals" de color gris o beix en forma cúbica.

Barbacoas de líneas rectas de estilo moderno, acabados "actuales" de color gris i beige en forma cúbica.

*Barbecues of straight lines of modern style, finished "actual" of gray color or beige cubical form.*

# MODERNES MODERNAS MODERN

# DELTA RECTE

- Campana de formigó refractari pintada i estucada en blanc.
- Sistema mata guspies.
- Interior de totxo i formigó refractari de 5 cm.
- Conjunt graella elevadora d'acer inoxidable de 82x52 cm.
- Calaixos per recollir les cendres independents.
- Escalfa carns.
- Pica esmaltada blanca.
- Suport, revestiment de formigó gris, taula amb rajola blanca.

- Campana en hormigón refractario pintada y estucada en blanco.
- Sistema salva chispas.
- Interior en ladrillo y hormigón refractario de 5 cm.
- Conjunto parrilla elevadora en acero inoxidable de 82x52 cm.
- Cajones para recoger las cenizas independientes.
- Calienta carne.
- Pila esmaltada blanca.
- Soporte, revestimiento en hormigón gris, mesas en gres blanco.

- 6
- *Refractory brick Hood, painted and stuccoed in White.*
  - *Anti-spark system.*
  - *Refractory brick and concrete interior 5 cm.*
  - *Stainless Steel rising grill unit 82x52 cm.*
  - *Meat-warmer.*
  - *Independent ash drawers.*
  - *White enamelled sink.*
  - *Support and lining in gray concrete, bench in white stoneware.*

## OPCIONES OPCIONES / OPTIONS



**Reversible**  
Reversible  
Reversible



**Graella 69/82 cm**  
Parrilla 69/82 cm  
Grill 69/82 cm



**Taula auxiliar**  
Mesa auxiliar  
Auxiliar table

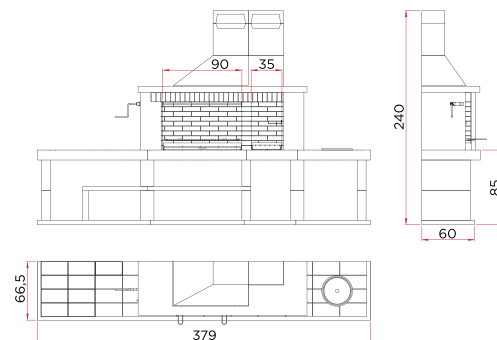

## OPCIONES DE MATERIALES OPCIONES DE MATERIALES / MATERIAL OPTIONS

### PREFABRICAT DE GRA DE MARBRE

PREFABRICADO DE GRANITO DE MÁRMOL  
PRECAST GRANITE MARBLE



**Negre**  
Negro  
Black



**Marró**  
Marrón  
Brown



**Blanc**  
Blanco  
White



**Beix**  
Beige  
Fawn

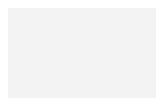
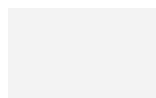

### COLOR CAMPANA COLOR CAMPANA / HOOD COLOUR

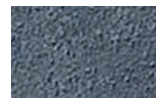

**Gris**  
Gris  
Gray



**Beix**  
Beige  
Fawn

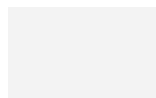
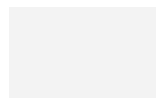
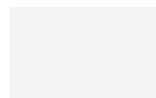

### MARBRE MÁRMOL / MARBLE

## COMPLEMENTS COMPLEMENTOS / ACCESSORIES

Ref. pàg.75



Ref. 110



Ref. 130



Ref. 150



Ref. 160



Ref. 190



Argemí®

# MONACO

- Campana exterior de fibra ciment \*(kit per peces).
- Campana interior de formigó refractari.
- Sistema mata guspies.
- Interior de totxo i formigó refractari de 5 cm.
- Tres posicions de guies per la graella d'acer inoxidable de 69x44 cm.
- Calaix per recollir les cendres independent.
- Taula, suport, revestiment de formigó gris, i gris tenyit negre, sobre de la taula en granit negre intens.

- Campana exterior de fibra cemento \* (kit por piezas).
- Campana interior en hormigón refractario .
- Sistema salva chispas.
- Interior en ladrillo y hormigón refractario de 5 cm.
- Tres posiciones de guías para la parrilla de acero inoxidable de 69x44 cm.
- Cajón para recoger las cenizas independiente.
- Mesa, soporte, revestimiento en hormigón gris, y gris tintado negro, sobre de la mesa en granito negro intenso.

- *Exterior Hood in fibra cement \* (kit in parts).*
- *Interior Hood in refractory concrete.*
- *Anti-spark system.*
- *Refractory brick and concrete interior 5 cm.*
- *Three positions for stainless Steel grill 69x44 cm.*
- *Independent ash drawer.*
- *Bench, support, lining in gray concrete, and gray dyed black, deep black granite side table.*

## OPCIONES OPCIONES / OPTIONS



Reversible  
Reversible  
Reversible



Graella 82 cm  
Parrilla 82 cm  
Grill 82 cm

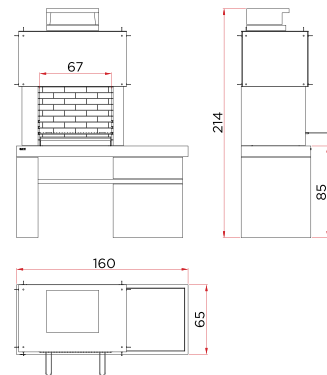

## OPCIONES DE MATERIALS OPCIONES DE MATERIALES / MATERIAL OPTIONS

**PREFABRICAT DE GRA DE MÀRBRE**  
PREFABRICADO DE GRANITO DE MÁRMOL  
PRECAST GRANITE MARBLE

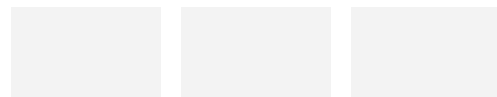

**PREFABRICAT DE CIMENT**  
PREFABRICADO DE CEMENTO  
PRECAST CONCRETE

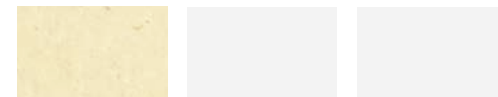

Beix  
Beige  
Fawn

**COLOR CAMPANA** COLOR CAMPANA / HOOD COLOUR

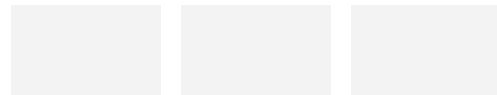

**MÀRBRE** MÁRMOL / MARBLE

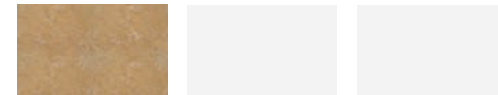

Cenia envellit  
Cenia envejecido  
Distressed Cenia

## COMPLEMENTS COMPLEMENTOS / ACCESSORIES

Ref. pàg.75



Ref. 110



Ref. 130



Ref. 150



Ref. 160

(\*) Cal una màquina rebladora manual pel muntatge.  
Se necesita una remachadora manual para el montaje.  
A manual riveter is needed form assembly.

Argemí



# LONDON

- Campana exterior de fibra ciment \*(kit per peces).
- Campana interior de formigó refractari.
- Sistema mata guspies.
- Interior de totxo i formigó refractari de 5 cm pintat negre.
- Tres posicions de guies per la graella d'acer inoxidable de 69x44 cm.
- Calaix per recollir les cendres independent.
- Pica esmaltada negra.
- Suport i revestiment de formigó gris, refractari de 5 cm pintat negre, sobre de la taula en granit negre intens.

- Campana exterior de fibra cemento \* (kit por piezas).
- Campana interior en hormigón refractario.
- Sistema salva chispas.
- Interior en ladrillo y hormigón refractario de 5 cm pintado negro.
- Tres posiciones de guías para la parrilla de acero inoxidable de 69x44 cm.
- Cajón para recoger las cenizas independiente.
- Pila esmaltada negra.
- Soporte y revestimiento en hormigón gris, refractario de 5 cm pintado en negro, sobre de la mesa en granito negro intenso.

- *Exterior Hood in fibra cement \* (kit in parts).*
- *Interior Hood in refractory concrete.*
- *Anti-spark system.*
- *Refractory brick and concrete interior 5 cm black painted.*
- *Three positions for stainless Steel grill 69x44 cm.*
- *Independent ash drawer.*
- *Sink enamelled in black.*
- *Support and lining in gray concrete, refractory bricks 5 cm black painted, deep black granite side table.*

## OPCIONES OPCIONES / OPTIONS



Reversible  
Reversible  
Reversible



Graella 82 cm  
Parrilla 82 cm  
Grill 82 cm

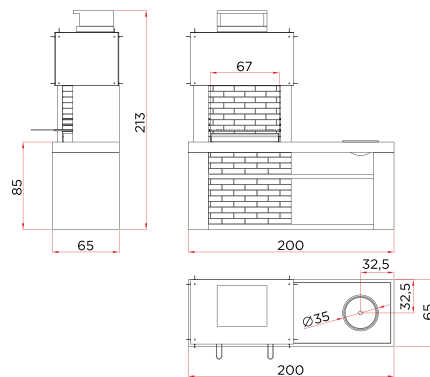

## OPCIONES DE MATERIALS OPCIONES DE MATERIALES / MATERIAL OPTIONS

**PREFABRICAT DE GRA DE MARBRE**  
PREFABRICADO DE GRANITO DE MÁRMOL  
PRECAST GRANITE MARBLE

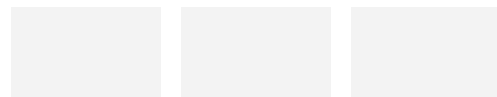

**PREFABRICAT DE CIMENT**  
PREFABRICADO DE CEMENTO  
PRECAST CONCRETE

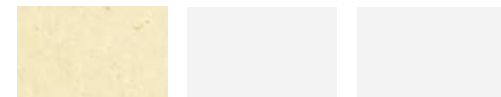

Beix  
Beige  
Fawn

**COLOR CAMPANA** COLOR CAMPANA / HOOD COLOUR

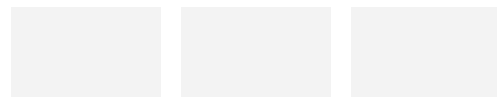

**MARBRE** MÁRMOL / MARBLE

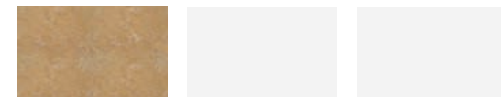

Cenia envellit  
Cenia envejecido  
Distressed Cenia

## COMPLEMENTS COMPLEMENTOS / ACCESSORIES

Ref. pàg.75



Ref. 110



Ref. 130



Ref. 150



Ref. 160

(\*) Cal una màquina rebladora manual pel muntatge.  
Se necesita una remachadora manual para el montaje.  
A manual riveter is needed for assembly.

Argemí



# TENERIFE

- Campana exterior de fibra ciment \*(kit per peces).
- Campana interior de formigó refractari.
- Sistema mata guspies.
- Interior de totxo i formigó refractari de 5 cm.
- Tres posicions de guies per la graella d'acer inoxidable de 69x44 cm.
- Calaix per recollir les cendres independent.
- Suport i revestiment de formigó beix, sobre de la taula i baixants en granit negre intens.

- Campana exterior de fibra cemento \*(kit por piezas).
- Campana interior en hormigón refractario.
- Sistema salva chispas.
- Interior en ladrillo y hormigón refractario de 5 cm.
- Tres posiciones de guías para la parrilla de acero inoxidable de 69x44 cm.
- Cajón para recoger las cenizas independiente.
- Soporte y revestimiento en hormigón beige, sobre de la mesa y bajantes en granito negro intenso.

- *Exterior Hood in fibra cement \*(kit in parts).*
- *Interior Hood in refractory concrete.*
- *Anti-spark system.*
- *Refractory brick and concrete interior 5 cm.*
- *Three positions for stainless Steel grill 69x44 cm.*
- *Independent ash drawer.*
- *Support and lining in beige concrete, refractory 5cm, black dyed concrete shelf, upper side table in deep black granite.*

## OPCIONES OPCIONES / OPTIONS

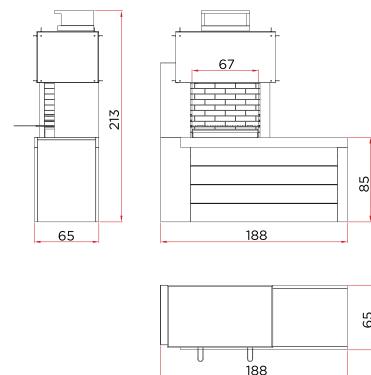

## OPCIONES DE MATERIALS OPCIONES DE MATERIALES / MATERIAL OPTIONS

**PREFABRICAT DE GRA DE MÀRBRE**  
 PREFABRICADO DE GRANITO DE MÁRMOL  
 PRECAST GRANITE MARBLE

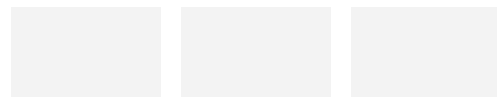

**PREFABRICAT DE CIMENT**  
 PREFABRICADO DE CEMENTO  
 PRECAST CONCRETE

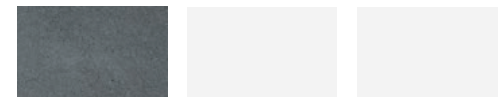

Color 250  
 Color 250  
 Color 250

**COLOR CAMPANA** COLOR CAMPANA / HOOD COLOUR

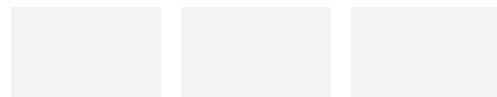

**MÀRBRE** MÁRMOL / MARBLE

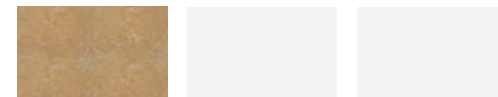

Cenia envellit  
 Cenia envejecido  
 Distressed Cenia

## COMPLEMENTS COMPLEMENTOS / ACCESSORIES

Ref. pàg.75



Ref. 110



Ref. 130



Ref. 150



Ref. 160

(\*) Cal una màquina rebladora manual pel muntatge.  
 Se necesita una remachadora manual para el montaje.  
 A manual riveter is needed for assembly.

Argemí



# CALELLA

- Campana exterior de fibra ciment \*(kit per peces).
- Campana interior de formigó refractari.
- Sistema mata guspies.
- Interior de totxo i formigó refractari de 5 cm.
- Tres posicions de guies, per a la graella d'acer inoxidable de 82x52 cm.
- Planxa elèctrica.
- Calaix per recollir les cendres independent.
- Suport i revestiment en formigó gris, prestatge en formigó tenyit negre, sobre de la taula en granit negre intens.
- Dues portes corredisses de fibra ciment.

- Campana exterior de fibra cemento \* (kit por piezas).
- Campana interior en hormigón refractario.
- Sistema salva chispas.
- Interior en ladrillo y hormigón refractario de 5 cm.
- Tres posiciones de guías para la parrilla de acero inoxidable de 82x52 cm.
- Plancha eléctrica.
- Cajón para recoger las cenizas independiente.
- Soporte y revestimiento en hormigón gris, estante en hormigón tintado negro, sobre de la mesa en granito negro intenso.
- Dos puertas correderas de fibra cemento.

- *Exterior Hood in fibra cement \* (kit in parts).*
- *Interior Hood in refractory concrete.*
- *Anti-spark system.*
- *Refractory brick and concrete interior 5 cm.*
- *Three positions for stainless Steel grill 82x52 cm.*
- *Electric grill.*
- *Independent ash drawer.*
- *Support and lining in gray concrete, shelf in dyed black, concrete deep black granite side table.*
- *Two sliding doors in fibra cement.*

## OPCIONES OPCIONES / OPTIONS



Reversible  
Reversible  
Reversible

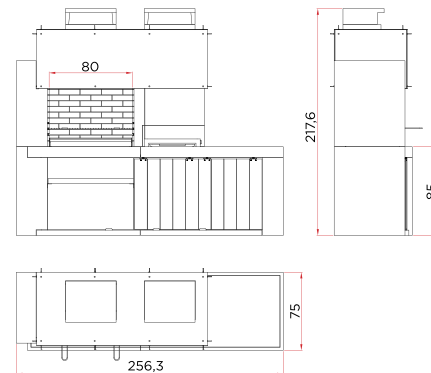

## OPCIONES DE MATERIALS OPCIONES DE MATERIALES / MATERIAL OPTIONS

**PREFABRICAT DE GRA DE MARBRE**  
PREFABRICADO DE GRANITO DE MÁRMOL  
PRECAST GRANITE MARBLE

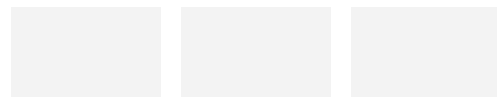

**PREFABRICAT DE CIMENT**  
PREFABRICADO DE CEMENTO  
PRECAST CONCRETE

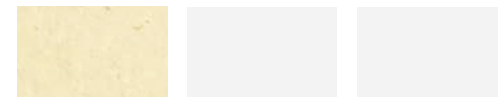

Beix  
Beige  
Fawn

**COLOR CAMPANA** COLOR CAMPANA / HOOD COLOUR

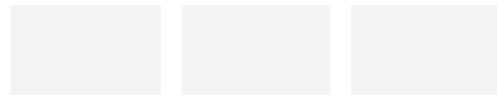

**MARBRE MÀRMOL / MARBLE**

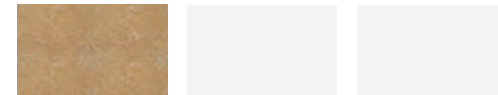

Cenia envellit  
Cenia envejecido  
Distressed Cenia

## COMPLEMENTS COMPLEMENTOS / ACCESSORIES

Ref. pàg.75



Ref. 110



Ref. 130



Ref. 150



Ref. 160

(\*) Cal una màquina rebladora manual pel muntatge.  
Se necesita una remachadora manual para el montaje.  
A manual riveter is needed for assembly.

Argemí®



# BARCELONA

- Campana exterior de fibra ciment \*(kit per peces).
- Campana interior de formigó refractari.
- Sistema mata guspies.
- Interior de totxo i formigó refractari de 5 cm.
- Conjunt graella elevadora d'acer inoxidable de 82x52 cm.
- Calaixos per recollir les cendres independents.
- Escalfa carns.
- Suport i revestiment en formigó beix, refractari de 5 cm, prestatge de formigó tenyit negre, sobre de la taula amb marbre Cenia envellit.
- Porta corredissa de fibra ciment.

- Campana exterior de fibra cemento \* (kit por piezas).
- Campana interior en hormigón refractario.
- Sistema salva chispas.
- Interior en ladrillo y hormigón refractario de 5 cm.
- Conjunto parrilla elevadora en acero inoxidable de 82x52 cm.
- Cajones para recoger las cenizas independientes.
- Calienta carne.
- Soporte y revestimiento en hormigón beige y refractario de 5 cm, estante en hormigón tintado negro, sobre de la mesa en mármol Cenia envejecido.
- Puerta corredera de fibra cemento.

- *Exterior Hood in fibra cement \* (kit in parts).*
- *Interior Hood in refractory concrete.*
- *Anti-spark system.*
- *Refractory brick and concrete interior 5 cm.*
- *Stainless Steel rising grill unit 82x52 cm.*
- *Meat-warmer.*
- *Independent ash drawers.*
- *Support and lining in beige concrete, refractory 5cm, black dyed concrete shelf, upper side table in old Cenia marble.*
- *One sliding door in fibra cement.*

## OPCIONES OPCIONES / OPTIONS

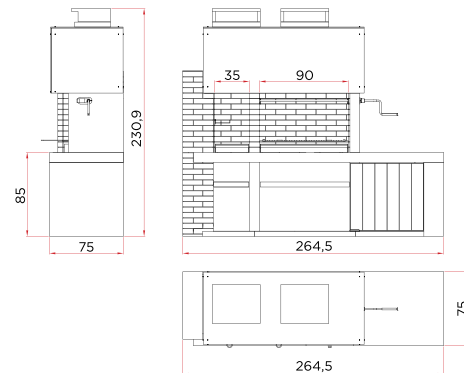

## OPCIONES DE MATERIALES OPCIONES DE MATERIALES / MATERIAL OPTIONS

**PREFABRICAT DE GRA DE MARBRE**  
PREFABRICADO DE GRANITO DE MÁRMOL  
PRECAST GRANITE MARBLE

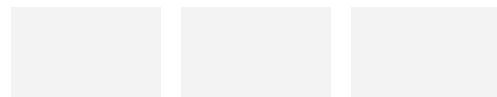

**PREFABRICAT DE CIMENT**  
PREFABRICADO DE CEMENTO  
PRECAST CONCRETE

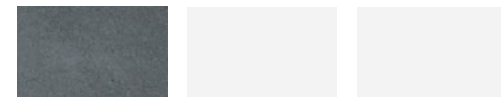

Color 250  
Color 250  
Color 250

**COLOR CAMPANA** COLOR CAMPANA / HOOD COLOUR

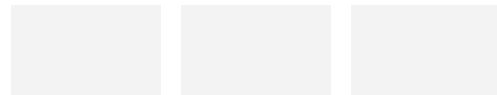

**MARBRE** MÁRMOL / MARBLE

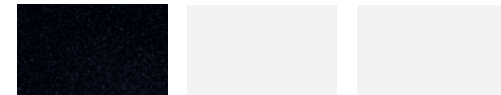

Granit negre intens  
Granito negro intenso  
Deep black granit

## COMPLEMENTS COMPLEMENTOS / ACCESSORIES

Ref. pàg.75



Ref. 110



Ref. 130



Ref. 150



Ref. 160

(\*) Cal una màquina rebladora manual pel muntatge.  
Se necesita una remachadora manual para el montaje.  
A manual riveter is needed for assembly.

Argemí



# MILANO

- Campana exterior de fibra ciment \*(kit per peces).
- Campana interior de formigó refractari.
- Sistema mata guspies.
- Interior de totxo i formigó refractari de 5 cm pintat negre.
- Tres posicions de guies per a la graella d'acer inoxidable de 69x44 cm.
- Calaix per recollir les cendres independent.
- Doble compartim per a la creació de brases.
- Suport i revestiment de formigó gris, refractari de 5 cm pintat negre, sobre de la taula en granit negre intens.

- Campana exterior de fibra cemento \* (kit por piezas).
- Campana interior en hormigón refractario.
- Sistema salva chispas.
- Interior en ladrillo y hormigón refractario de 5 cm pintado negro.
- Tres posiciones de guías para la parrilla de acero inoxidable de 69x44 cm.
- Cajón para recoger las cenizas independiente.
- Doble compartimiento para la creación de brases.
- Soporte y revestimiento en hormigón gris, refractario de 5cm pintado en negro, sobre de la mesa en granito negro intenso.

- *Exterior Hood in fibra cement \* (kit in parts).*
- *Interior Hood in refractory concrete.*
- *Anti-spark system.*
- *Refractory brick and concrete interior 5 cm black painted.*
- *Three positions for stainless Steel grill 69x44 cm.*
- *Independent ash drawer.*
- *Double compartment for embers.*
- *Support and lining in gray concrete, refractory bricks 5cm black painted, deep black granite side table.*

## OPCIONES OPCIONES / OPTIONS



Reversible  
Reversible  
Reversible

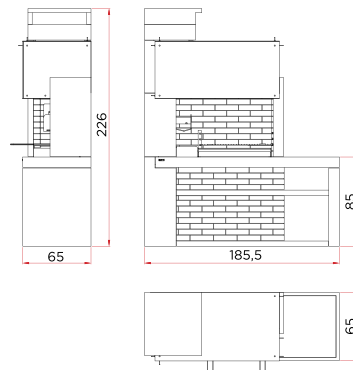

## OPCIONES DE MATERIALS OPCIONES DE MATERIALES / MATERIAL OPTIONS

**PREFABRICAT DE GRA DE MARBRE**  
PREFABRICADO DE GRANITO DE MÁRMOL  
PRECAST GRANITE MARBLE

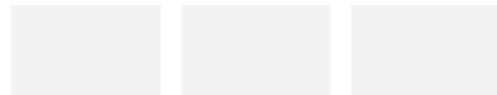

**PREFABRICAT DE CIMENT**  
PREFABRICADO DE CEMENTO  
PRECAST CONCRETE

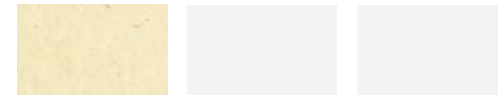

Beix  
Beige  
Fawn

**COLOR CAMPANA** COLOR CAMPANA / HOOD COLOUR

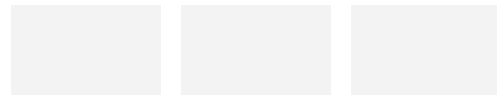

**MARBRE** MÁRMOL / MARBLE

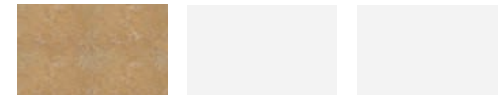

Cenia envellit  
Cenia envejecido  
Distressed Cenia

## COMPLEMENTS COMPLEMENTOS / ACCESSORIES

Ref. pàg.75



Ref. 130



Ref. 150



Ref. 160

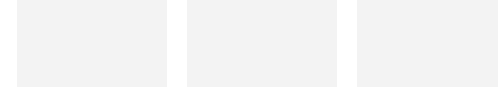
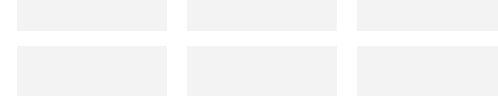
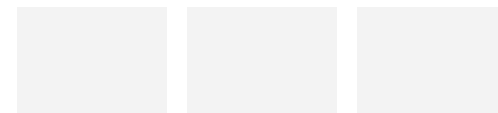

(\*) Cal una màquina rebladora manual pel muntatge.  
Se necesita una remachadora manual para el montaje.  
A manual riveter is needed for assembly.

Argemí®



# BERLIN

- Campana exterior de fibra ciment \* (kit per peces).
- Campana interior de formigó refractari.
- Sistema mata guspies.
- Interior de totxo i formigó refractari de 5 cm.
- Tres posicions per a la graella d'acer inoxidable de 82x52 cm.
- Calaixos per recollir les cendres independents.
- Pica esmaltada negra.
- Suport i revestiment de formigó gris, sobre de les taules i baixants en granit negre intens.

- Campana exterior de fibra cemento \* (kit por piezas).
- Campana interior en hormigón refractario.
- Sistema salva chispas.
- Interior en ladrillo y hormigón refractario de 5 cm.
- Tres posiciones para parrilla de acero inoxidable de 82x52 cm.
- Cajones para recoger las cenizas independientes.
- Pila esmaltada negra.
- Soporte y revestimiento en hormigón gris, sobre de las mesas y bajantes en granito negro intenso.

- *Exterior Hood in fibra cement \* (kit in parts).*
- *Refractory Hood in refractory concrete.*
- *Anti-spark system.*
- *Refractory brick and concrete interior 5 cm.*
- *Three positions for stainless steel grill 82x52 cm.*
- *Independent ash drawers.*
- *Sink enamelled in black.*
- *Support and lining in gray concrete and upper and down side table in deep black granite.*

## OPCIONES OPCIONES / OPTIONS



**Graella 69 cm**  
Parrilla 69 cm  
Grill 69 cm

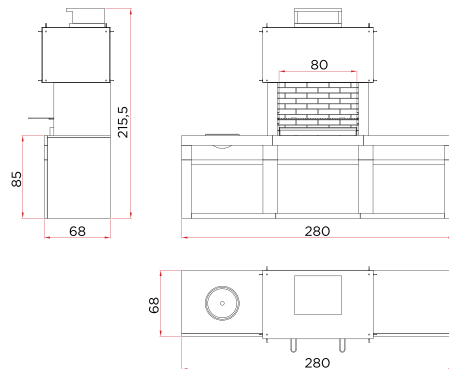

## OPCIONES DE MATERIALES OPCIONES DE MATERIALES / MATERIAL OPTIONS

**PREFABRICAT DE GRA DE MARBRE**  
PREFABRICADO DE GRANITO DE MÁRMOL  
PRECAST GRANITE MARBLE

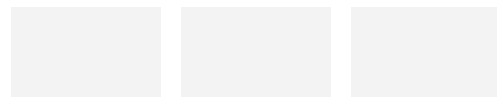

**PREFABRICAT DE CIMENT**  
PREFABRICADO DE CEMENTO  
PRECAST CONCRETE

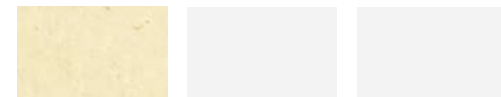

**Beix**  
Beige  
Fawn

**COLOR CAMPANA** COLOR CAMPANA / HOOD COLOUR

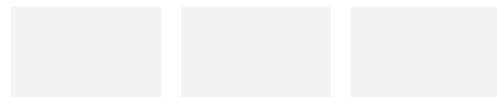

**MARBRE** MÁRMOL / MARBLE

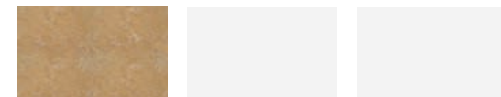

**Cenia envellit**  
Cenia envejecido  
Distressed Cenia

## COMPLEMENTS COMPLEMENTOS / ACCESSORIES

Ref. pàg.75



Ref. 110



Ref. 130



Ref. 150



Ref. 160



Ref. 190

(\*) Cal una màquina rebladora manual pel muntatge.  
Se necesita una remachadora manual para el montaje.  
A manual riveter is needed for assembly.

Argemí



# MALTA

- Campana exterior de fibra ciment \*(kit per peces).
- Campana interior de formigó refractari.
- Sistema mata guspies.
- Interior de totxo i formigó refractari de 5 cm.
- Tres posicions de guies per la graella d'acer inoxidable de 69x44 cm.
- Calaix per recollir les cendres independent.
- Taula, suport, revestiment de formigó beix, i gris tenyit negre, sobre de la taula en cenja envellit.

- Campana exterior de fibra cemento \*(kit por piezas).
- Campana interior en hormigón refractario.
- Sistema salva chispas.
- Interior en ladrillo y hormigón refractario de 5 cm.
- Tres posiciones de guías para la parrilla de acero inoxidable de 69x44 cm.
- Cajón para recoger las cenizas independiente.
- Mesa, soporte, revestimiento en hormigón beige, y gris tintado negro, sobre de la mesa en Cenja envejecido.

- *Exterior Hood in fibra cement \*(kit in parts).*
- *Interior Hood in refractory concrete.*
- *Anti-spark system.*
- *Refractory brick and concrete interior 5 cm.*
- *Three positions for stainless Steel grill 69x44 cm.*
- *Independent ash drawer.*
- *Bench, support, lining in fawn concrete, and beige concrete, deep black Cenja granite side table.*

## OPCIONES OPCIONES / OPTIONS



Reversible  
Reversible  
Reversible



Graella 82 cm  
Parrilla 81 cm  
Grill 82 cm

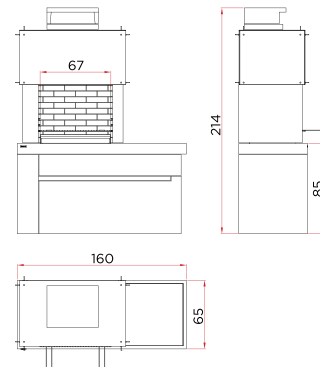

## OPCIONES DE MATERIALES OPCIONES DE MATERIALES / MATERIAL OPTIONS

**PREFABRICAT DE GRA DE MARBRE**  
PREFABRICADO DE GRANITO DE MÁRMOL  
PRECAST GRANITE MARBLE

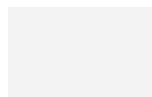
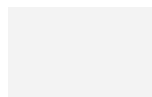
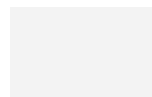
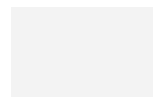
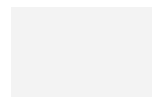

**PREFABRICAT DE CIMENT**  
PREFABRICADO DE CEMENTO  
PRECAST CONCRETE

Color 250  
Color 250  
Color 250

**COLOR CAMPANA** COLOR CAMPANA / HOOD COLOUR

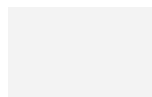
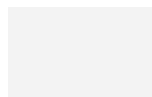
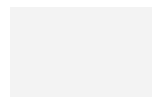
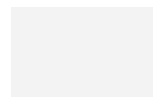
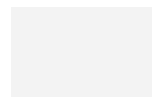

**MARBRE** MÁRMOL / MARBLE

Granit negre intens  
Granito negro intenso  
Deep black granit

## COMPLEMENTS COMPLEMENTOS / ACCESSORIES

Ref. pàg.75



Ref. 110



Ref. 130



Ref. 150



Ref. 160

(\*) Cal una màquina rebladora manual per al muntatge.  
Se necesita una remachadora manual para el montaje.  
A manual riveter is needed form assembly.

Argemí



# OLOT

- Campana exterior de fibra ciment \*(kit per peces).
- Campana interior de formigó refractari.
- Sistema mata guspies.
- Interior de totxo i formigó refractari de 5 cm.
- Tres posicions de guies per la graella d'acer inoxidable de 82x53 cm.
- Calaix per recollir les cendres independent.
- Pica quadrada negra de 34 cm.
- Taula, suport, revestiment de formigó gris, i gris tenyit negre, sobre de la taula en granit negre intens.
- Portes corredissa de fibra ciment.

- Campana exterior de fibra cemento \* (kit por piezas).
- Campana interior en hormigón refractario.
- Sistema salva.
- Interior en ladrillo y hormigón refractario de 5 cm.
- Tres posiciones de guías para la parrilla de acero inoxidable de 82x53 cm.
- Cajón para recoger las cenizas independiente.
- Pila cuadrada negra de 34 cm.
- Mesa, soporte, revestimiento en hormigón gris, y gris tintado negro, sobre de la mesa en granito negro intenso.
- Puertas corredera de fibra cemento.

- *Exterior Hood in fibra cement \* (kit in parts).*
- *Interior Hood in refractory concrete.*
- *Anti-spark system.*
- *Refractory brick and concrete interior 5 cm.*
- *Three positions for stainless Steel grill 82x53 cm.*
- *Independent ash drawer.*
- *34 cm square black sink.*
- *Bench, support, lining in gray concrete, and gray dyed black, deep black granite side table.*
- *Two sliding door in fibra cement.*

## OPCIONES OPCIONES / OPTIONS



Reversible  
Reversible  
Reversible



Graella 82 cm  
Parrilla 81 cm  
Grill 82 cm

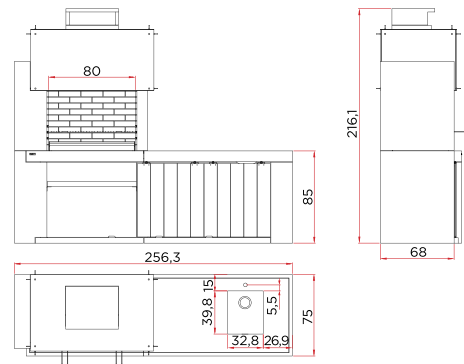

## OPCIONES DE MATERIALS OPCIONES DE MATERIALES / MATERIAL OPTIONS

**PREFABRICAT DE GRA DE MARBRE**  
PREFABRICADO DE GRANITO DE MÁRMOL  
PRECAST GRANITE MARBLE

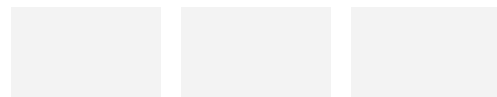

**PREFABRICAT DE CIMENT**  
PREFABRICADO DE CEMENTO  
PRECAST CONCRETE

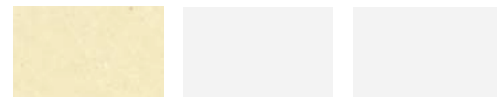

Beix  
Beige  
Fawn

**COLOR CAMPANA** COLOR CAMPANA / HOOD COLOUR

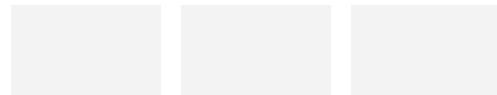

**MARBRE** MÁRMOL / MARBLE

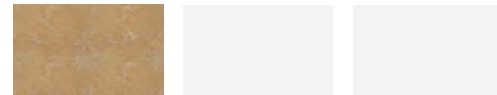

Cenia envellit  
Cenia envejecido  
Distressed Cenia

## COMPLEMENTS COMPLEMENTOS / ACCESSORIES

Ref. pàg.75



Ref. 110



Ref. 130



Ref. 150



Ref. 160

(\*) Cal una màquina rebladora manual pel muntatge.  
Se necesita una remachadora manual para el montaje.  
A manual riveter is needed form assembly.

Argemí®



<b>MODERNES</b>	
DELTA RECTE	6
MONACO	8
LONDON	10
TENERIFE	12
CALELLA	14
BARCELONA	16
MILANO	18
BERLIN	20
MALTA	22
OLOT	24

<b>TRADICIONALS</b>	
ROMA	28
ARAN	30
ARAN LD/LI	30
ATENES	32
ATENES LD	32
OSLO	34
PATERNA	36
ESTIVELLA	38
NOGUERA	40
EMPORDÀ	42
GARROTXA	44
OSONA	46
MONTSEGRIÀ TR	48
URGELL	50
URGELL FL/LD	52

<b>METÀL·LIQUES</b>	
SELVA	56
CANNES	56

<b>RÚSTIQUES</b>	
NIZA	60
TERRA ALTA	62
GARRIGUES	64
PALLARS	66
BERGUEDÀ	68
SEGARRA	70
MANAUS	72
QUITO	73
FORN	73
MALLORCA	74
MALLORCA LD/LI	74

Barbacoes d'aire mediterrani,  
d'estil tradicional.

Barbacoas de aire mediterráneo,  
de estilo tradicional.

*Mediterranean air barbecue,  
traditional style.*

# TRADICIONALS

# TRADICIONALES

# TRADITIONAL

# ROMA

- Campana de formigó refractari pintada i estucada en gris-negre.
- Sistema mata guspies.
- Interior de totxo i formigó refractari de 5 cm.
- Tres posicions per a la graella d'acer inoxidable de 69x44 cm.
- Calaix per recollir les cendres independent.
- Taula lateral en gres natural.
- Suport, revestiment i prestatges intermedis de formigó gris.

- Campana en hormigón refractario pintada y estucada en gris-negro.
- Sistema salva chispas.
- Interior en ladrillo y hormigón refractario de 5 cm.
- Tres posiciones para la parrilla de acero inoxidable de 69x44 cm.
- Cajón para recoger las cenizas independiente.
- Mesa lateral en ladrillo gres natural.
- Soporte, revestimiento y estantes intermedios en hormigón gris.

- *Refractory concrete hood, painted and stuccoed in gray and black.*
- *Anti-spark system.*
- *Refractory brick and concrete interior 5 cm.*
- *Three positions for stainless steel grill 69x44 cm.*
- *Independent ash drawer.*
- *Stoneware side table.*
- *Support, lining and shelves in gray concrete.*

## OPCIONES OPCIONES / OPTIONS



**Reversible**  
Reversible  
Reversible



**Graella 82 cm**  
Parrilla 82 cm  
Grill 82 cm



**Taula auxiliar**  
Mesa auxiliar  
Auxiliar table



**Pica**  
Pila  
Sink

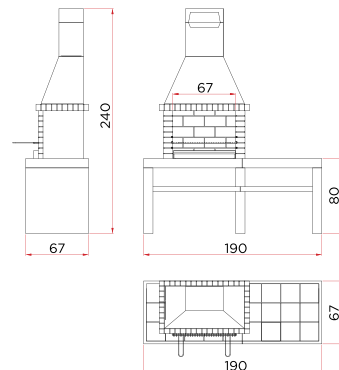

## OPCIONES DE MATERIALES OPCIONES DE MATERIALES / MATERIAL OPTIONS

### PREFABRICAT DE GRA DE MARBRE

PREFABRICADO DE GRANITO DE MÁRMOL  
PRECAST GRANITE MARBLE



**Negre**  
Negro  
Black



**Marró**  
Marrón  
Brown



**Blanc**  
Blanco  
White



**Beix**  
Beige  
Fawn

### COLOR CAMPANA

COLOR CAMPANA / HOOD COLOUR

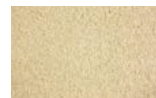

**Beix**  
Beige  
Fawn

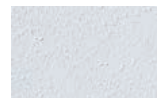

**Blanc**  
Blanco  
White

### MARBRE MÁRMOL / MARBLE

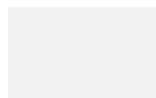
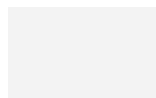
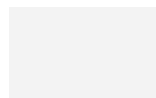

## COMPLEMENTS COMPLEMENTOS / ACCESSORIES

Ref. pàg.75



Ref. 110



Ref. 130



Ref. 150



Ref. 160



Ref. 190

Argemí



# ARAN

- Campana de formigó refractari sense pintar.
- Sistema mata guspies.
- Interior de totxo i formigó refractari de 5 cm.
- Tres posicions per a la graella d'acer inoxidable de 59x44 cm.
- Taulell, taula lateral i suport amb prestatge intermedi en formigó gris sense pintar.

- Campana en hormigón refractario sin pintar.
- Sistema salva chispas.
- Interior en ladrillo y hormigón refractario de 5 cm.
- Tres posiciones para la parrilla de acero inoxidable de 59x44 cm.
- Encimera, mesa lateral y soporte con estante intermedio en hormigón gris sin pintar.

- *Refractory concrete hood without painting.*
- *Anti-spark system.*
- *Refractory brick and concrete interior 5 cm.*
- *Three positions for stainless steel grill 59x44 cm.*
- *Gray concrete without painting worktop, side table and support with shelf.*

Ref. ARAN LD/LI



## OPCIONES OPCIONES / OPTIONS



**Reversible**  
Reversible  
Reversible



**Pintura i selladora**  
Pintura y selladora  
Paint and sealing

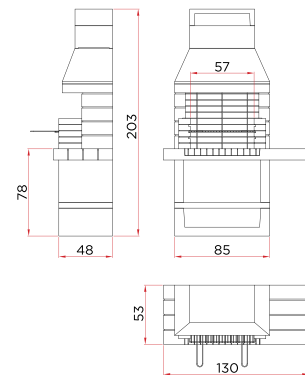

## OPCIONES DE MATERIALS OPCIONES DE MATERIALES / MATERIAL OPTIONS

**PREFABRICAT DE GRA DE MARBRE**  
PREFABRICADO DE GRANITO DE MÁRMOL  
PRECAST GRANITE MARBLE

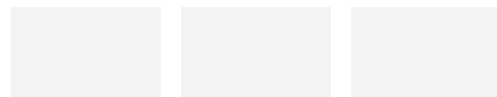

**PREFABRICAT DE CIMENT**  
PREFABRICADO DE CEMENTO  
PRECAST CONCRETE

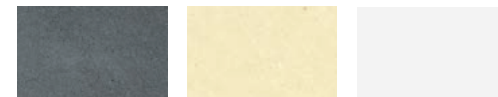

**Color 250**  
Color 250  
Color 250

**Beix**  
Beige  
Fawn

**COLOR CAMPANA** COLOR CAMPANA / HOOD COLOUR

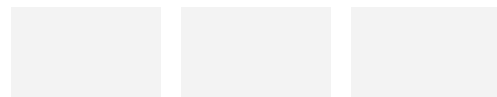

**MARBRE MÁRMOL / MARBLE**

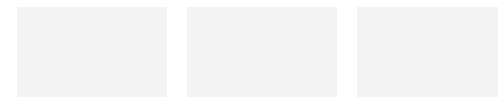

## COMPLEMENTS COMPLEMENTOS / ACCESSORIES

Ref. pàg.75



Ref. 130



Ref. 150



Ref. 170



Ref. 190

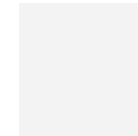
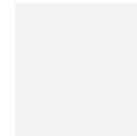
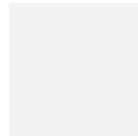
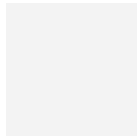
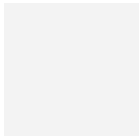
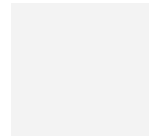

Argemí



# ATENES

- Campana de formigó refractari pintada i estucada en gris-negre.
- Sistema mata guspaires.
- Interior de totxo i formigó refractari de 5 cm.
- Tres posicions per a la graella d'acer inoxidable de 82x52 cm.
- Calaix per recollir les cendres independent.
- Pica esmaltada en negre.
- Suport i revestiment en formigó gris, sobre de les taules i baixants en granet negre intens.

- Campana en hormigón refractario pintada y estucada en gris-negro.
- Sistema salva chispas.
- Interior en ladrillo y hormigón refractario de 5 cm.
- Tres posiciones para la parrilla de acero inoxidable de 82x52 cm.
- Cajón para recoger las cenizas independiente.
- Pila esmaltada negra.
- Soporte y revestimiento en hormigón gris, sobre de las mesas y bajantes en granito negro intenso.

- *Refractory concrete hood, painted and stuccoed in gray and black.*
- *Anti-spark system.*
- *Refractory brick and concrete interior 5 cm.*
- *Three positions for stainless steel grill 82x52 cm.*
- *Independent ash drawer.*
- *Sink enamelled in black.*
- *Support and lining in gray concrete, upper and down side table in deep black granite.*

Ref. ATENES LD



## OPCIONES OPCIONES / OPTIONS



**Graella 69 cm**  
Parrilla 69 cm  
Grill 69 cm

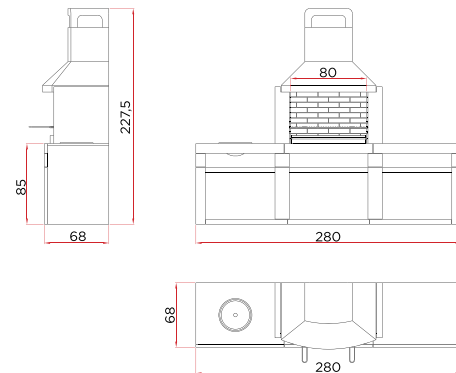

## OPCIONES DE MATERIALS OPCIONES DE MATERIALES / MATERIAL OPTIONS

**PREFABRICAT DE GRA DE MARBRE**  
PREFABRICADO DE GRANITO DE MÁRMOL  
PRECAST GRANITE MARBLE



**Negre**  
Negro  
Black

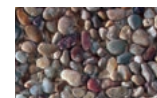

**Marró**  
Marrón  
Brown



**Blanc**  
Blanco  
White



**Beix**  
Beige  
Fawn

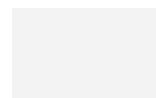
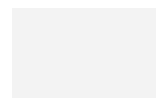

**COLOR CAMPANA** COLOR CAMPANA / HOOD COLOUR

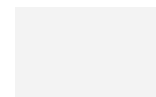

**Beix**  
Beige  
Fawn

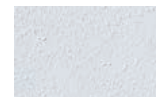

**Blanc**  
Blanco  
White

**MARBRE** MÁRMOL / MARBLE



**Cenia envellit**  
Cenia envejecido  
Distressed Cenia

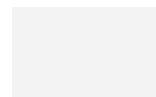
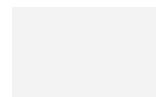

## COMPLEMENTS COMPLEMENTOS / ACCESSORIES

Ref. pàg.75



Ref. 110



Ref. 130



Ref. 150



Ref. 160



Ref. 190

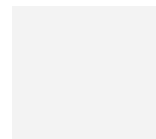
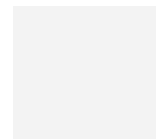
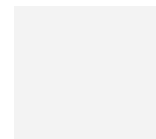
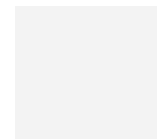
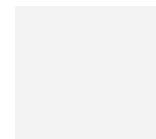

# OSLO

- Campana de formigó refractari pintada i estucada en gris-negre.
- Sistema mata guspies.
- Interior de totxo i formigó refractari de 5 cm.
- Tres posicions per a la graella d'acer inoxidable de 82x52 cm.
- Calaix per recollir les cendres independent.
- Taula lateral en maó refractari i gres natural.
- Suport, revestiment i prestatge intermedi de formigó gris.

- Campana en hormigón refractario pintada y estucada en gris-negro.
- Sistema salva chispas.
- Interior en ladrillo y hormigón refractario de 5 cm.
- Tres posiciones para la parrilla de acero inoxidable de 82x52 cm.
- Cajón para recoger las cenizas independiente.
- Mesa lateral en ladrillo refractario y gres natural.
- Soporte, revestimiento y estante intermedio en hormigón gris.

- *Refractory concrete hood, painted and stuccoed in gray and black.*
- *Anti-spark system.*
- *Refractory brick and concrete interior 5 cm.*
- *Three positions for stainless steel grill 82x52 cm.*
- *Independent ash drawer.*
- *Refractory brick and stoneware upper side table.*
- *Support, lining and shelf in gray concrete.*

## OPCIONES OPCIONES / OPTIONS



**Reversible**  
Reversible  
Reversible



**Taula auxiliar**  
Mesa auxiliar  
Auxiliar table



**Pica**  
Pila  
Sink



**Portes**  
Puertas  
Doors

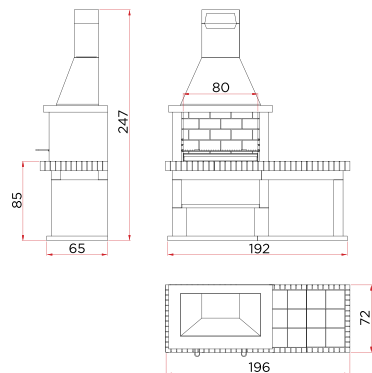

## OPCIONES DE MATERIALS OPCIONES DE MATERIALES / MATERIAL OPTIONS

**PREFABRICAT DE GRA DE MARBRE**  
PREFABRICADO DE GRANITO DE MÁRMOL  
PRECAST GRANITE MARBLE



**Negre**  
Negro  
Black



**Marró**  
Marrón  
Brown



**Blanc**  
Blanco  
White



**Beix**  
Beige  
Fawn

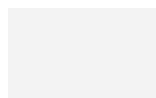
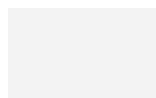

**COLOR CAMPANA** COLOR CAMPANA / HOOD COLOUR

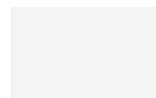

**Beix**  
Beige  
Fawn

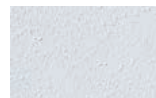

**Blanc**  
Blanco  
White

**MARBRE** MÁRMOL / MARBLE

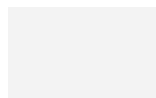
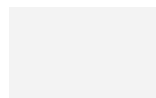

## COMPLEMENTS COMPLEMENTOS / ACCESSORIES

Ref. pàg.75



Ref. 110



Ref. 130



Ref. 150



Ref. 160



Ref. 190



# PATERNA

- Campana de formigó refractari pintada i estucada en blanc.
- Sistema mata guspires.
- Interior de totxo i formigó refractari de 5 cm.
- Tres posicions per a la graella d'acer inoxidable de 82x52 cm.
- Taula lateral en maó refractari i gres natural.
- Suport en gra de marbre blanc amb prestatges intermedis en totxo refractari i gres natural.

- Campana en hormigón refractario pintada y estucada en blanco.
- Sistema salva chispas.
- Interior en ladrillo y hormigón refractario de 5 cm.
- Tres posiciones para la parrilla de acero inoxidable de 82x52 cm.
- Mesa lateral en ladrillo refractario y gres natural.
- Soporte en grano de mármol blanco con estantes intermedios en ladrillo refractario y gres natural.

- *Refractory concrete hood, painted and stuccoed in white.*
- *Anti-spark system.*
- *Refractory brick and concrete interior 5 cm.*
- *Three positions for stainless steel grill 82x52 cm.*
- *Stoneware and white marble grain side table.*
- *White marble grain support with grain and heat resistant brick shelf.*

## OPCIONES OPCIONES / OPTIONS



**Reversible**  
Reversible  
Reversible



**Taula auxiliar**  
Mesa auxiliar  
Auxiliar table



**Pica**  
Pila  
Sink



**Portes**  
Puertas  
Doors

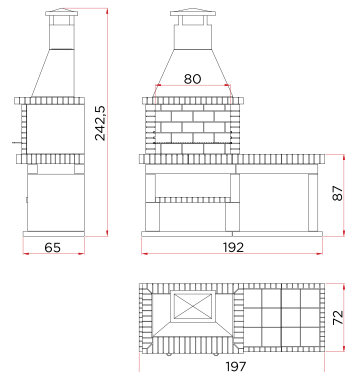

## OPCIONES DE MATERIALES OPCIONES DE MATERIALES / MATERIAL OPTIONS

### PREFABRICAT DE GRA DE MARBRE

PREFABRICADO DE GRANITO DE MÁRMOL  
PRECAST GRANITE MARBLE



**Negre**  
Negro  
Black



**Marró**  
Marrón  
Brown

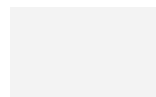

**Color 250**  
Color 250  
Color 250

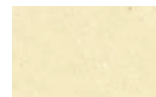

**Beix**  
Beige  
Fawn

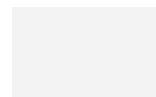

### COLOR CAMPANA COLOR CAMPANA / HOOD COLOUR



**Gris**  
Gris  
Gray

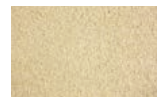

**Beix**  
Beige  
Fawn

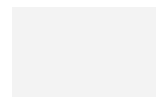
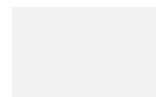
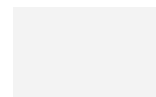
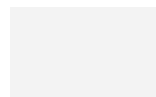

### MARBRE MÁRMOL / MARBLE

## COMPLEMENTS COMPLEMENTOS / ACCESSORIES

Ref. pàg.75



Ref. 110



Ref. 130



Ref. 150



Ref. 160



Ref. 170



Ref. 190

Argemí



# ESTIVELLA

- Campana de formigó refractari pintada i estucada en blanc.
- Sistema mata guspies.
- Interior de totxo i formigó refractari de 5 cm.
- Tres posicions per a la graella d'acer inoxidable de 82x52 cm.
- Suport en gra de marbre blanc amb prestatges intermedis en totxo refractari.

- Campana en hormigón refractario pintada y estucada en blanco.
- Sistema salva chispas.
- Interior en ladrillo y hormigón refractario de 5 cm.
- Tres posiciones para la parrilla de acero inoxidable de 82x52 cm.
- Soporte en grano de mármol blanco con estantes intermedios en ladrillo refractario.

- *Refractory concrete hood, painted and stuccoed in white.*
- *Anti-spark system.*
- *Refractory brick and concrete interior 5 cm.*
- *Three positions for stainless steel grill 82x52 cm.*
- *Stoneware and white marble grain side table.*
- *White marble grain support with refractory brick shelve.*

## OPCIONES OPCIONES / OPTIONS



**Taula auxiliar**  
Mesa auxiliar  
Auxiliar table

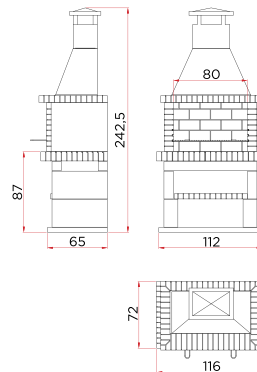

## OPCIONES DE MATERIALES OPCIONES DE MATERIALES / MATERIAL OPTIONS

### PREFABRICAT DE GRA DE MARBRE

PREFABRICADO DE GRANITO DE MÁRMOL  
PRECAST GRANITE MARBLE



**Negre**  
Negro  
Black



**Marró**  
Marrón  
Brown

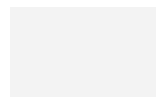

**Color 250**  
Color 250  
Color 250

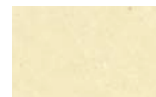

**Beix**  
Beige  
Fawn

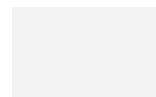

### COLOR CAMPANA COLOR CAMPANA / HOOD COLOUR



**Gris**  
Gris  
Gray

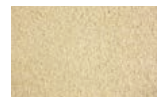

**Beix**  
Beige  
Fawn

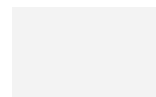
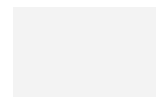
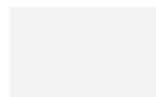

### MARBRE MÁRMOL / MARBLE

## COMPLEMENTS COMPLEMENTOS / ACCESSORIES

Ref. pàg.75



Ref. 110



Ref. 130



Ref. 150



Ref. 160



Ref. 170



Ref. 190

Argemí®



# NOGUERA

- Campana de formigó refractari pintada i estucada en blanc.
- Sistema mata guspies.
- Interior de totxo i formigó refractari de 5 cm.
- Tres posicions per a la graella d'acer inoxidable de 69x44 cm.
- Calaix de cendres incorporat.
- Taules laterals i pica de gres natural amb perfil en gra de marbre blanc.
- Suport en gra de marbre blanc amb amplis llenyers.

## OPCIONES OPCIONES / OPTIONS



**Reversible**  
Reversible  
Reversible



**Graella 82 cm**  
Parrilla 82 cm  
Grill 82 cm



**Taula auxiliar**  
Mesa auxiliar  
Auxiliar table



**Portes**  
Puertas  
Doors

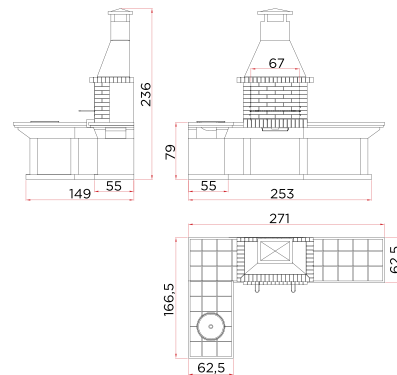

## OPCIONES DE MATERIALS OPCIONES DE MATERIALES / MATERIAL OPTIONS

**PREFABRICAT DE GRA DE MARBRE**  
PREFABRICADO DE GRANITO DE MÁRMOL  
PRECAST GRANITE MARBLE



**Negre**  
Negro  
Black



**Marró**  
Marrón  
Brown

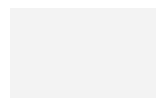

**Color 250**  
Color 250  
Color 250



**Beix**  
Beige  
Fawn

**COLOR CAMPANA** COLOR CAMPANA / HOOD COLOUR



**Gris**  
Gris  
Gray

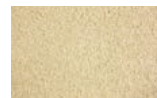

**Beix**  
Beige  
Fawn

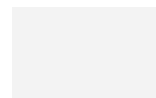
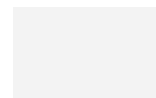
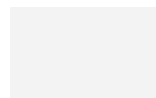

**MARBRE** MÁRMOL / MARBLE

## COMPLEMENTS COMPLEMENTOS / ACCESSORIES

Ref. pàg.75



Ref. 110



Ref. 130



Ref. 150



Ref. 160



Ref. 190

Argemí



# EMPORDÀ

- Campana de formigó refractari pintada i estucada en blanc.
- Sistema mata guspies.
- Interior de totxo i formigó refractari de 5 cm.
- Tres posicions per a la graella d'acer inoxidable de 69x44 cm.
- Calaix de cendres incorporat.
- Taules laterals i pica de gres natural amb perfil en gra de marbre blanc.
- Suport en gra de marbre blanc amb amplis llenyers.

## OPCIONES OPCIONES / OPTIONS



**Reversible**  
Reversible  
Reversible



**Graella 82 cm**  
Parrilla 82 cm  
Grill 82 cm



**Taula auxiliar**  
Mesa auxiliar  
Auxiliar table



**Portes**  
Puertas  
Doors

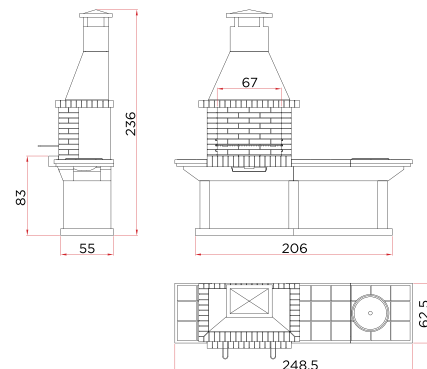

- Campana en hormigón refractario pintada y estucada en blanco.
- Sistema salva chispas.
- Interior en ladrillo y hormigón refractario de 5 cm.
- Tres posiciones para la parrilla de acero inoxidable de 69x44 cm.
- Cajón recoge cenizas incorporado.
- Mesas laterales y pila de gres natural con perfil en grano de mármol blanco.
- Soporte en grano de mármol blanco con amplios leñeros.

## OPCIONES DE MATERIALS OPCIONES DE MATERIALES / MATERIAL OPTIONS

**PREFABRICAT DE GRA DE MARBRE**  
PREFABRICADO DE GRANITO DE MÁRMOL  
PRECAST GRANITE MARBLE



**Negre**  
Negro  
Black



**Marró**  
Marrón  
Brown

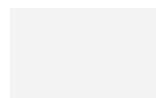

**Color 250**  
Color 250  
Color 250

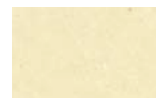

**Beix**  
Beige  
Fawn

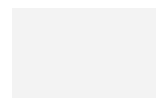

- *Refractory concrete hood, painted and stuccoed in white.*
- *Anti-spark system.*
- *Refractory brick and concrete interior 5 cm.*
- *Three positions for stainless steel grill 69x44 cm.*
- *Integral ash drawer.*
- *Side table and sink in white marble grain.*
- *White marble grain support with wide woodsheds.*

**COLOR CAMPANA** COLOR CAMPANA / HOOD COLOUR



**Gris**  
Gris  
Gray

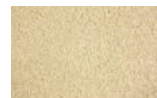

**Beige**  
Beige  
Fawn

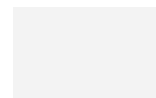
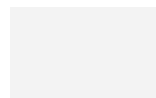

**MARBRE** MÁRMOL / MARBLE

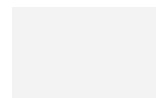
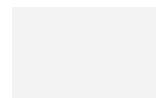

## COMPLEMENTS COMPLEMENTOS / ACCESSORIES

Ref. pàg.75



Ref. 110



Ref. 130



Ref. 150



Ref. 160



Ref. 190

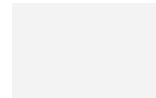
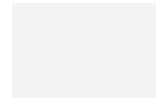
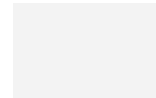
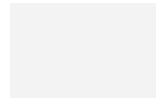
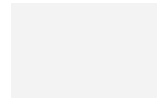
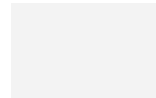

Argemí



# GARROTXA

- Campana de formigó refractari pintada i estucada en blanc.
- Sistema mata guspires.
- Interior de totxo i formigó refractari de 5 cm.
- Tres posicions per a la graella d'acer inoxidable de 69x44 cm.
- Calaix de cendres incorporat.
- Taules laterals de gres natural amb perfil en gra de marbre blanc.
- Suport en gra de marbre blanc.

- Campana en hormigón refractario pintada y estucada en blanco.
- Sistema salva chispas.
- Interior en ladrillo y hormigón refractario de 5 cm.
- Tres posiciones para la parrilla de acero inoxidable de 69x44 cm.
- Cajón recoge cenizas incorporado.
- Mesas laterales de gres natural con perfil en grano de mármol blanco.
- Soporte en grano de mármol blanco.

- *Refractory concrete hood, painted and stuccoed in white.*
- *Anti-spark system.*
- *Refractory brick and concrete interior 5 cm.*
- *Three positions for stainless steel grill 69x44 cm.*
- *Integral ash drawer.*
- *Stoneware and white marble grain side tables.*
- *White marble grain support.*

## OPCIONES OPCIONES / OPTIONS



**Graella 82 cm**  
Parrilla 82 cm  
Grill 82 cm



**Portes**  
Puertas  
Doors

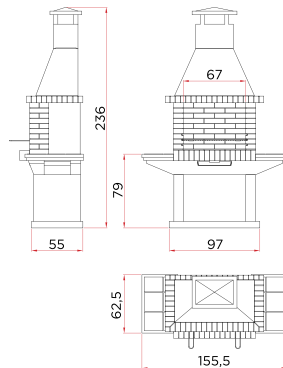

## OPCIONES DE MATERIALS OPCIONES DE MATERIALES / MATERIAL OPTIONS

### PREFABRICAT DE GRA DE MARBRE

PREFABRICADO DE GRANITO DE MÁRMOL  
PRECAST GRANITE MARBLE



**Negre**  
Negro  
Black



**Marró**  
Marrón  
Brown

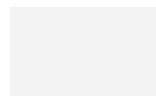

**Color 250**  
Color 250  
Color 250

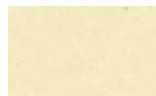

**Beix**  
Beige  
Fawn

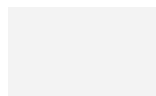

### COLOR CAMPANA COLOR CAMPANA / HOOD COLOUR



**Gris**  
Gris  
Gray



**Beix**  
Beige  
Fawn

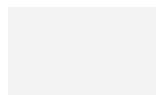
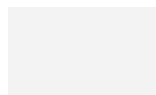
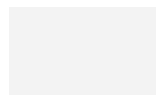
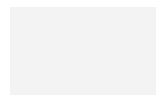

### MARBRE MÁRMOL / MARBLE

## COMPLEMENTS COMPLEMENTOS / ACCESSORIES

Ref. pàg.75



Ref. 110



Ref. 130



Ref. 150



Ref. 160



Ref. 190

Argemí



# OSONA

- Campana de formigó refractari pintada i estucada en blanc.
- Sistema mata guspires.
- Interior de totxo i formigó refractari de 5 cm.
- Tres posicions per a la graella d'acer inoxidable de 70x70 cm.
- Calaix de cendres incorporat.
- Taulell en gra de marbre polit color marró.
- Suport en gra de marbre marró amb prestatge intermedi.

- Campana en hormigón refractario pintada y estucada en blanco.
- Sistema salva chispas.
- Interior en ladrillo y hormigón refractario de 5 cm.
- Tres posiciones para la parrilla de acero inoxidable de 70x70 cm.
- Cajón recoge cenizas incorporado.
- Encimera en grano de mármol pulido color marrón.
- Soporte en grano de mármol marrón con estante intermedio.

- *Refractory concrete hood, painted and stuccoed in white.*
- *Anti-spark system.*
- *Refractory brick and concrete interior 5 cm.*
- *Three positions for stainless steel grill 70x70 cm.*
- *Integral ash drawer.*
- *Brown marble grain worktop.*
- *Brown marble grain support with shelve.*

## OPCIONES OPCIONES / OPTIONS



Reversible  
Reversible  
Reversible



Taula auxiliar  
Mesa auxiliar  
Auxiliar table

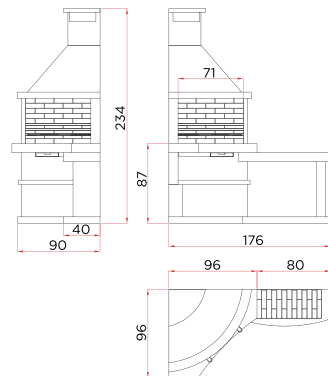

## OPCIONES DE MATERIALES OPCIONES DE MATERIALES / MATERIAL OPTIONS

**PREFABRICAT DE GRA DE MARBRE**  
PREFABRICADO DE GRANITO DE MÁRMOL  
PRECAST GRANITE MARBLE



Negre  
Negro  
Black



Blanc  
Blanco  
White

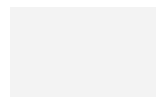

Color 250  
Color 250  
Color 250

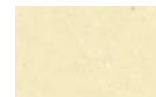

Beix  
Beige  
Fawn

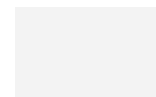

**COLOR CAMPANA** COLOR CAMPANA / HOOD COLOUR



Gris  
Gris  
Gray

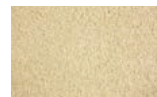

Beix  
Beige  
Fawn

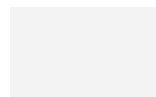

**MARBRE MÁRMOL / MARBLE**

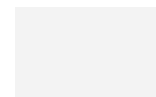
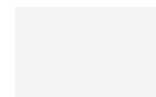

## COMPLEMENTOS COMPLEMENTOS / ACCESSORIES

Ref. pàg.75



Ref. 150



Ref. 160



Ref. 190

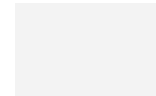
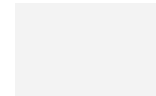
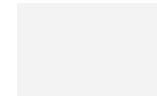
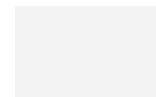
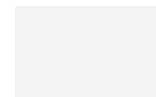
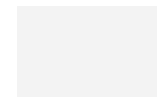

Argemí



# MONTSEGRIÀ TR

- Campana de formigó refractari pintada i estucada en blanc.
- Sistema mata guspies.
- Interior de totxo i formigó refractari de 5 cm.
- Tres posicions per a la graella d'acer inoxidable de 69x44 cm.
- Calaix de cendres independent.
- Taulell i taules laterals de totxo refractari i gres natural.
- Suport en gra de marbre blanc amb prestatges intermedis.

- Campana en hormigón refractario pintada y estucada en blanco.
- Sistema salva chispas.
- Interior en ladrillo y hormigón refractario de 5 cm.
- Tres posiciones para la parrilla de acero inoxidable de 69x44 cm.
- Cajón de cenizas independiente.
- Encimera y mesas laterales en ladrillo refractario y gres natural.
- Soporte en grano de mármol blanco con estantes intermedios.

- *Refractory concrete hood, painted and stuccoed in white.*
- *Anti-spark system.*
- *Refractory brick and concrete interior 5 cm.*
- *Three positions for stainless steel grill 69x44 cm.*
- *Independent ash drawer.*
- *Refractory brick and grain worktop and side tables.*
- *White marble grain support with shelves.*

## OPCIONES OPCIONES / OPTIONS



Reversible  
Reversible  
Reversible



Graella 82 cm  
Parrilla 82 cm  
Grill 82 cm



Taula auxiliar  
Mesa auxiliar  
Auxiliar table



Pica  
Pila  
Sink

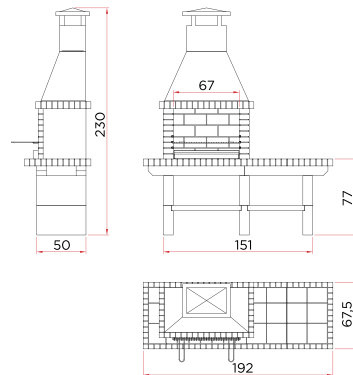

## OPCIONES DE MATERIALES OPCIONES DE MATERIALES / MATERIAL OPTIONS

### PREFABRICAT DE GRA DE MARBRE

PREFABRICADO DE GRANITO DE MÁRMOL  
PRECAST GRANITE MARBLE



Negre  
Negro  
Black



Marró  
Marrón  
Brown

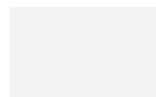

Color 250  
Color 250  
Color 250

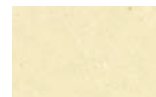

Beix  
Beige  
Fawn

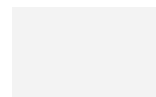

### COLOR CAMPANA COLOR CAMPANA / HOOD COLOUR



Gris  
Gris  
Gray

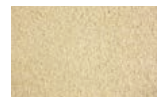

Beix  
Beige  
Fawn

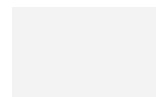
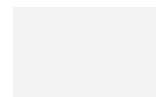
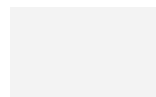

### MARBRE MÁRMOL / MARBLE

## COMPLEMENTS COMPLEMENTOS / ACCESSORIES

Ref. pàg.75



Ref. 110



Ref. 130



Ref. 150



Ref. 160



Ref. 190



Argemí

# URGELL

- Campana de formigó refractari pintada i estucada en beix.
- Sistema mata guspies.
- Interior de totxo i formigó refractari de 5 cm.
- Tres posicions per a la graella d'acer inoxidable de 69x44 cm.
- Calaix de cendres incorporat.
- Taules laterals de totxo refractari.
- Suport en gra de marbre marró amb prestatge intermedi.

- Campana en hormigón refractario pintada y estucada en beige.
- Sistema salva chispas.
- Interior en ladrillo y hormigón refractario de 5 cm.
- Tres posiciones para la parrilla de acero inoxidable de 69x44 cm.
- Cajón recoge cenizas incorporado.
- Mesas laterales en ladrillo refractario.
- Soporte en grano de mármol marrón con estante intermedio.

- *Refractory concrete Hood painted and stuccoed in fawn.*
- *Anti-spark system.*
- *Refractory brick and concrete interior 5 cm.*
- *Three positions for stainless steel grill 69x44 cm.*
- *Integral ash drawer.*
- *Refractory brick side tables.*
- *Brown marble grain support with shelf.*

## OPCIONES OPCIONES / OPTIONS



**Graella 82 cm**  
Parrilla 82 cm  
Grill 82 cm



**Taula auxiliar**  
Mesa auxiliar  
Auxiliar table



**Pica**  
Pila  
Sink

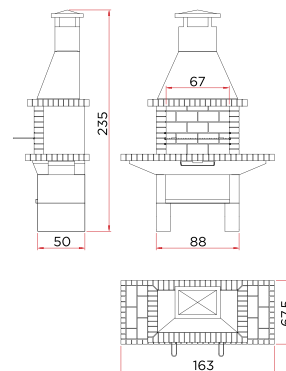

## OPCIONES DE MATERIALES OPCIONES DE MATERIALES / MATERIAL OPTIONS

### PREFABRICAT DE GRA DE MARBRE

PREFABRICADO DE GRANITO DE MÁRMOL  
PRECAST GRANITE MARBLE



**Negre**  
Negro  
Black



**Marró**  
Marrón  
Brown

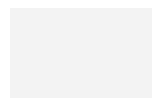

**Color 250**  
Color 250  
Color 250

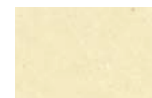

**Beix**  
Beige  
Fawn

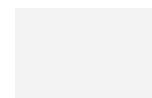

### COLOR CAMPANA COLOR CAMPANA / HOOD COLOUR



**Gris**  
Gris  
Gray

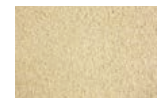

**Beix**  
Beige  
Fawn

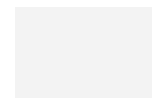
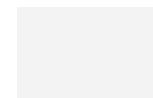
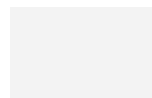

### MARBRE MÁRMOL / MARBLE

## COMPLEMENTS COMPLEMENTOS / ACCESSORIES

Ref. pàg.75



Ref. 110



Ref. 130



Ref. 150



Ref. 160



Ref. 190



Argemí

# URGELL FL/LD

- Campana de formigó refractari pintada i estucada en beix.
- Sistema mata guspires.
- Interior de totxo i formigó refractari de 5 cm.
- Tres posicions per a la graella d'acer inoxidable de 69x44 cm.
- Calaix de cendres incorporat.
- Taules laterals de totxo refractari i gres natural.
- Suport en gra de marbre marró amb prestatge intermedi.

- Campana en hormigón refractario pintada y estucada en beige.
- Sistema salva chispas.
- Interior en ladrillo y hormigón refractario de 5 cm.
- Tres posiciones para la parrilla de acero inoxidable de 69x44 cm.
- Cajón recoge cenizas incorporado.
- Mesas laterales en ladrillo refractario y gres natural.
- Soporte en grano de mármol marrón con estante intermedio.

- *Refractory concrete Hood painted and stuccoed in fawn.*
- *Anti-spark system.*
- *Refractory brick and concrete interior 5 cm.*
- *Three positions for stainless steel grill 69x44 cm.*
- *Integral ash drawer.*
- *Refractory brick side tables and stoneware.*
- *Brown marble grain support with shelf.*

## OPCIONES OPCIONES / OPTIONS

 **Graella 82 cm**  
Parrilla 82 cm  
Grill 82 cm

 **Taula auxiliar**  
Mesa auxiliar  
Auxiliar table

 **Pica**  
Pila  
Sink

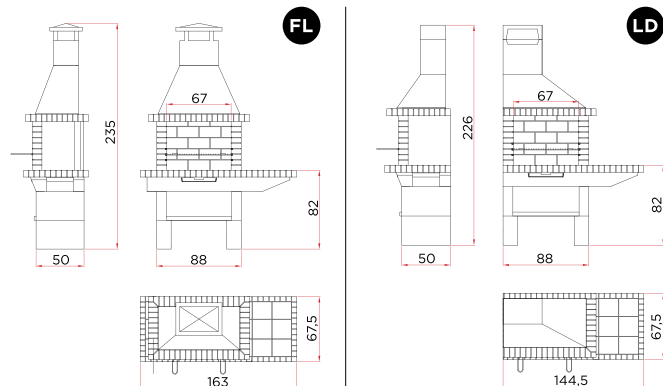

## OPCIONES DE MATERIALES OPCIONES DE MATERIALES / MATERIAL OPTIONS

**PREFABRICAT DE GRA DE MÀRBRE**  
PREFABRICADO DE GRANITO DE MÁRMOL  
PRECAST GRANITE MARBLE



**Negre**  
Negro  
Black

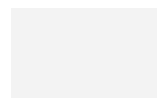

**Blanc**  
Blanco  
White



**Color 250**  
Color 250  
Color 250

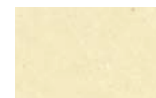

**Beix**  
Beige  
Fawn

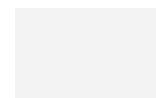

**COLOR CAMPANA** COLOR CAMPANA / HOOD COLOUR



**Gris**  
Gris  
Gray

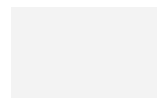

**Blanc**  
Blanco  
White

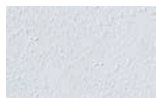

**MÀRBRE** MÁRMOL / MARBLE

## COMPLEMENTS COMPLEMENTOS / ACCESSORIES



Ref. 110



Ref. 130



Ref. 150



Ref. 160



Ref. 190

Ref. pag.57



<b>MODERNES</b>	
DELTA RECTE	6
MONACO	8
LONDON	10
TENERIFE	12
CALELLA	14
BARCELONA	16
MILANO	18
BERLIN	20
MALTA	22
OLOT	24

<b>TRADICIONALS</b>	
ROMA	28
ARAN	30
ARAN LD/LI	30
ATENES	32
ATENES LD	32
OSLO	34
PATERNA	36
ESTIVELLA	38
NOGUERA	40
EMPORDÀ	42
GARROTXA	44
OSONA	46
MONTSEGRÌÀ TR	48
URGELL	50
URGELL FL/LD	52

<b>METÀL-LIQUES</b>	
SELVA	56
CANNES	56

<b>RÚSTIQUES</b>	
NIZA	60
TERRA ALTA	62
GARRIGUES	64
PALLARS	66
BERGUEDÀ	68
SEGARRA	70
MANAUS	72
QUITO	73
FORN	73
MALLORCA	74
MALLORCA LD/LI	74

Barbacoes metàl·liques, mixtes d'acer inoxidable combinades amb formigó, molt lleugeres.

Barbacoas metálicas, mixtas de acero inoxidable combinadas con hormigón, muy ligeras.

*Metal barbecues, mixed in stainless steel combined with concrete, very light.*

# METÀL-LIQUES

# METÁLICAS

# METALLIC

# SELVA

- Campana en acer inoxidable pintada en negre.
- Sistema mata guspies.
- Interior de totxo i formigó refractari de 5 cm.
- Dues posicions per a la graella d'acer inoxidable de 53,5x32 cm.
- Taulell de gres natural.
- Suport en gra de marbre blanc.

- Campana en acero inoxidable pintada en negro.
- Sistema salva chispas.
- Interior en ladrillo y hormigón refractario de 5 cm.
- Dos posiciones para la parrilla de acero inoxidable de 53,5x32 cm.
- Encimera en gres natural.
- Soporte en grano de mármol blanco.

- *Stainless steel hood in black.*
- *Anti-spark system.*
- *Refractory brick and concrete interior 5 cm.*
- *Two positions for stainless steel grill 53,5x32 cm.*
- *Grain worktop.*
- *White marble grain support.*

Ref. CANNES



## OPCIONES OPCIONES / OPTIONS



Reversible  
Reversible  
Reversible



Taula auxiliar  
Mesa auxiliar  
Auxiliar table

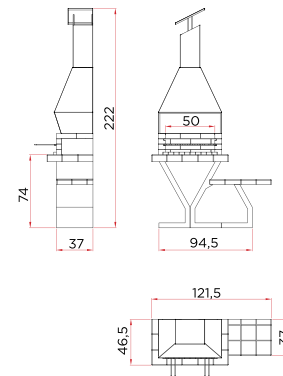

## OPCIONES DE MATERIALS OPCIONES DE MATERIALES / MATERIAL OPTIONS

### PREFABRICAT DE GRA DE MARBRE

PREFABRICADO DE GRANITO DE MÁRMOL  
PRECAST GRANITE MARBLE



Negre  
Negro  
Black



Marró  
Marrón  
Brown

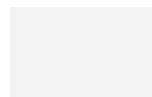

Color 250  
Color 250  
Color 250

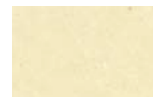

Beix  
Beige  
Fawn

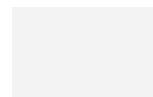

### COLOR CAMPANA COLOR CAMPANA / HOOD COLOUR

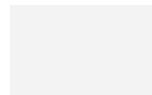
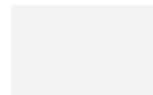
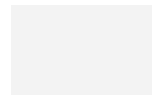

### MARBRE MÁRMOL / MARBLE

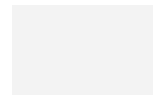
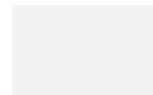

## COMPLEMENTS COMPLEMENTOS / ACCESSORIES



Ref. 130



Ref. 150

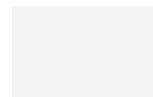
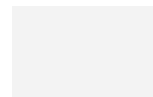
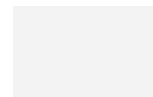
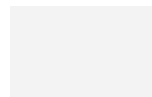

Ref. pàg.75



**MODERNES**

DELTA RECTE	6
MONACO	8
LONDON	10
TENERIFE	12
CALELLA	14
BARCELONA	16
MILANO	18
BERLIN	20
MALTA	22
OLOT	24

**TRADICIONALS**

ROMA	28
ARAN	30
ARAN LD/LI	30
ATENES	32
ATENES LD	32
OSLO	34
PATERNA	36
ESTIVELLA	38
NOGUERA	40
EMPORDÀ	42
GARROTXA	44
OSONA	46
MONTSEGRIÀ TR	48
URGELL	50
URGELL FL/LD	52

**METÀL·LIQUES**

SELVA	56
CANNES	56

**RÚSTIQUES**

NIZA	60
TERRA ALTA	62
GARRIGUES	64
PALLARS	66
BERGUEDÀ	68
SEGARRA	70
MANAUS	72
QUITO	73
FORN	73
MALLORCA	74
MALLORCA LD/LI	74

Barbacoes tradicional d'estil rústic,  
acabats en pedra natural.

Barbacoas tradicionales de estilo  
rústico, acabadps en piedra natural.

*Traditional rustic-style barbecues,  
finished in natural stone.*

# RÚSTIQUES RÚSTICAS RÚSTIC

# NIZA

- Campana de formigó refractari pintada i estucada en gris.
- Sistema mata guspies.
- Interior de totxo i formigó refractari de 5 cm.
- Tres posicions per a la graella d'acer inoxidable de 82x52 cm.
- Calaix de cendres incorporat.
- Taules laterals i pica de gres natural amb perfil en gra de marbre negre.
- Suport en pedra natural amb ampli llenyer.

- Campana en hormigón refractario pintada y estucada en gris.
- Sistema salva chispas.
- Interior en ladrillo y hormigón refractario de 5 cm.
- Tres posiciones para la parrilla de acero inoxidable de 82x52 cm.
- Cajón recoge cenizas incorporado.
- Mesas laterales y pila de gres natural con perfil en grano de mármol negro.
- Soporte en piedra natural con amplio leñero.

- *Refractory concrete hood, painted and stuccoed in gray.*
- *Anti-spark system.*
- *Refractory brick and concrete interior 5 cm.*
- *Three positions for stainless steel grill 82x52 cm.*
- *Integral ash drawer.*
- *Side tables and stack of sandstone with black grain profile marble.*
- *Natural stone support with woodshed.*

## OPCIONES OPCIONES / OPTIONS



**Reversible**  
Reversible  
Reversible



**Graella 69 cm**  
Parrilla 69 cm  
Grill 69 cm



**Taula auxiliar**  
Mesa auxiliar  
Auxiliar table



**Profunditat pilars**  
Profundidad pilares  
Depth of pillars

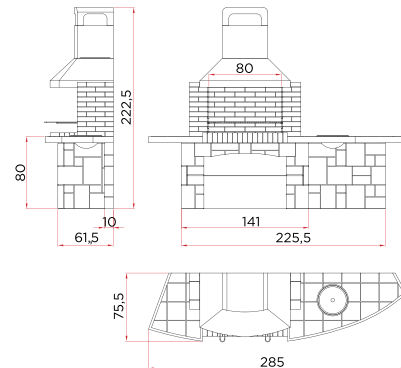

## OPCIONES DE MATERIALES OPCIONES DE MATERIALES / MATERIAL OPTIONS

**PREFABRICAT DE GRA DE MARBRE**  
PREFABRICADO DE GRANITO DE MÁRMOL  
PRECAST GRANITE MARBLE

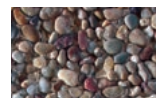

**Marró**  
Marrón  
Brown



**Blanc**  
Blanco  
White

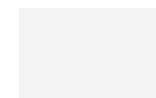
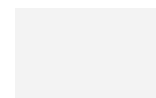
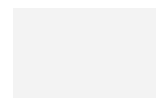
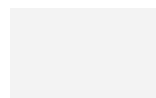

**PREFABRICAT DE CIMENT**  
PREFABRICADO DE CEMENTO  
PRECAST CONCRETE

**COLOR CAMPANA** COLOR CAMPANA / HOOD COLOUR

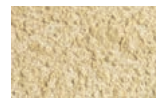

**Beix**  
Beige  
Fawn

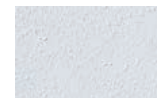

**Blanc**  
Blanco  
White

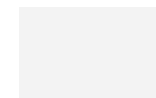
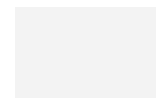
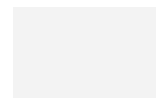
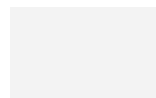

**MARBRE** MÁRMOL / MARBLE

## COMPLEMENTS COMPLEMENTOS / ACCESSORIES

Ref. pàg.75



Ref. 110



Ref. 130



Ref. 150



Ref. 160



Ref. 190



# TERRA ALTA

- Campana de formigó refractari pintada i estucada en gris.
- Sistema mata guspires.
- Interior de totxo i formigó refractari de 5 cm.
- Tres posicions per a la graella d'acer inoxidable de 82x52 cm.
- Calaix de cendres incorporat.
- Taules laterals de gres natural amb perfil en gra de marbre negre.
- Suport en pedra natural.

## OPCIONES OPCIONES / OPTIONS



**Taula auxiliar**  
Mesa auxiliar  
Auxiliar table



**Graella 69 cm**  
Parrilla 69 cm  
Grill 69 cm



**Pica**  
Pila  
Sink



**Profunditat pilars**  
Profundidad pilares  
Depth of pillars

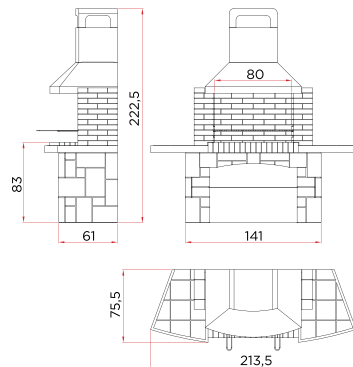

- Campana en hormigón refractario pintada y estucada en gris.
- Sistema salva chispas.
- Interior en ladrillo y hormigón refractario de 5 cm.
- Tres posiciones para la parrilla de acero inoxidable de 82x52 cm.
- Cajón recoge cenizas incorporado.
- Mesas laterales de gres natural con perfil en grano de mármol negro.
- Soporte en piedra natural.

## OPCIONES DE MATERIALS OPCIONES DE MATERIALES / MATERIAL OPTIONS

**PREFABRICAT DE GRA DE MARBRE**  
PREFABRICADO DE GRANITO DE MÁRMOL  
PRECAST GRANITE MARBLE

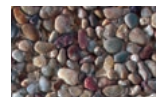

**Marró**  
Marrón  
Brown



**Blanc**  
Blanco  
White

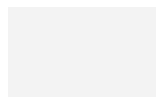
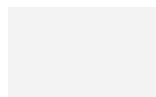
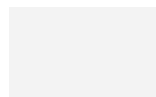
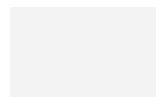

**PREFABRICAT DE CIMENT**  
PREFABRICADO DE CEMENTO  
PRECAST CONCRETE

**COLOR CAMPANA** COLOR CAMPANA / HOOD COLOUR



**Beix**  
Beige  
Fawn

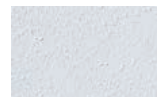

**Blanc**  
Blanco  
White

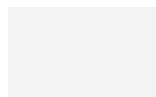
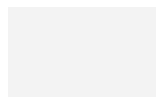
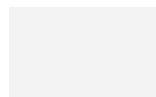
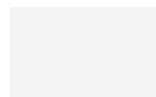

**MARBRE MÁRMOL / MARBLE**

- *Refractory concrete hood, painted and stuccoed in gray.*
- *Anti-spark system.*
- *Refractory brick and concrete interior 5 cm.*
- *Three positions for stainless steel grill 82x52 cm.*
- *Integral ash drawer.*
- *Stoneware and black marble grain and side tables.*
- *Natural stone support.*

## COMPLEMENTS COMPLEMENTOS / ACCESSORIES

Ref. pàg.75



Ref. 110



Ref. 130



Ref. 150



Ref. 160



Ref. 190

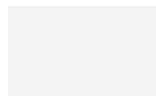
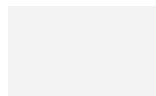
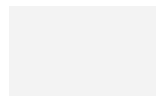
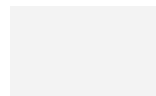
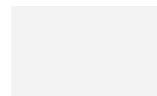
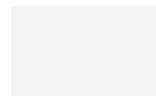

Argemí



# GARRIGUES

- Campana de formigó refractari pintada i estucada en gris.
- Sistema mata guspies.
- Interior de totxo i formigó refractari de 5 cm.
- Tres posicions per a la graella d'acer inoxidable de 82x52 cm.
- Taules laterals de totxo refractari.
- Suport en pedra natural.

- Campana en hormigón refractario pintada y estucada en gris.
- Sistema salva chispas.
- Interior en ladrillo y hormigón refractario de 5 cm.
- Tres posiciones para la parrilla de acero inoxidable de 82x52 cm.
- Mesas laterales en ladrillo refractario.
- Soporte en piedra natural.

- *Refractory concrete hood, painted and stuccoed in gray.*
- *Anti-spark system.*
- *Refractory brick and concrete interior 5 cm.*
- *Three positions for stainless steel grill 82x52 cm.*
- *Heat resistant brick side tables.*
- *Natural stone support.*

## OPCIONES OPCIONES / OPTIONS



**Taula auxiliar**  
Mesa auxiliar  
Auxiliar table



**Graella 69 cm**  
Parrilla 69 cm  
Grill 69 cm



**Pica**  
Pila  
Sink



**Profunditat pilars**  
Profundidad pilares  
Depth of pillars

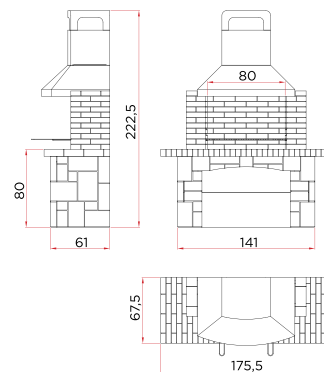

## OPCIONES DE MATERIALES OPCIONES DE MATERIALES / MATERIAL OPTIONS

**PREFABRICAT DE GRA DE MARBRE**  
PREFABRICADO DE GRANITO DE MÁRMOL  
PRECAST GRANITE MARBLE

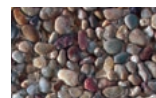

**Marró**  
Marrón  
Brown



**Blanc**  
Blanco  
White

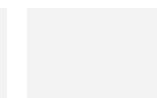
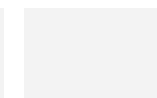
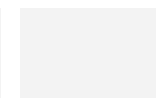
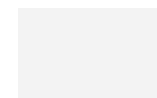

**PREFABRICAT DE CIMENT**  
PREFABRICADO DE CEMENTO  
PRECAST CONCRETE

**COLOR CAMPANA** COLOR CAMPANA / HOOD COLOUR

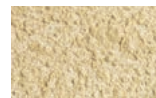

**Beix**  
Beige  
Fawn

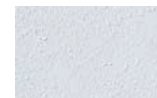

**Blanc**  
Blanco  
White

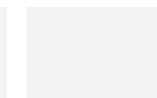
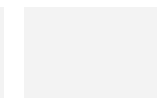
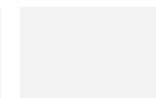
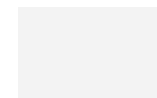

**MARBRE MÁRMOL / MARBLE**

## COMPLEMENTS COMPLEMENTOS / ACCESSORIES

Ref. pàg.75



Ref. 110



Ref. 130



Ref. 150



Ref. 160



Ref. 170



Ref. 190



# PALLARS

- Campana de formigó refractari pintada i estucada en blanc.
- Sistema mata guspires
- Interior de totxo i formigó refractari de 5 cm.
- Tres posicions per a la graella d'acer inoxidable de 69x44 cm.
- Calaix per recollir les cendres independent.
- Bancs i taules laterals de gres natural.
- Llinda de gres natural.
- Suport en gra de marbre color marró amb amplis llenyers.

- Campana en hormigón refractario pintada y estucada en blanco.
- Sistema salva chispas.
- Interior en ladrillo y hormigón refractario de 5 cm.
- Tres posiciones para la parrilla de acero inoxidable de 69x44 cm.
- Cajón para recoger las cenizas independiente.
- Encimeras y mesas laterales de gres natural.
- Dintel en gres natural.
- Soporte en grano de mármol marrón con amplios leñeros.

- *Refractory concrete Hood painted and stuccoed in white.*
- *Anti-spark system.*
- *Refractory brick and concrete interior 5 cm.*
- *Three positions for stainless steel grill 69x44 cm.*
- *Independent ash drawer.*
- *Grain side benches and tables.*
- *Grain lintel.*
- *Brown-coloured marble grain support with wide woodsheds.*

## OPCIONES OPCIONES / OPTIONS



**Reversible**  
Reversible  
Reversible



**Graella 82 cm**  
Parrilla 81 cm  
Grill 82 cm



**Taula auxiliar**  
Mesa auxiliar  
Auxiliar table



**Pica**  
Pila  
Sink

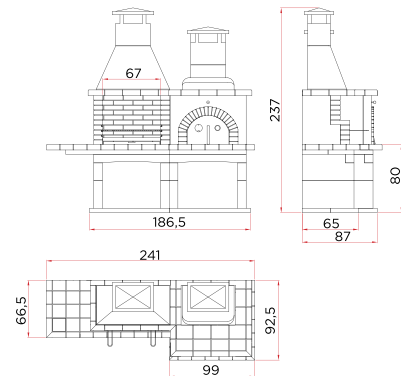

## OPCIONES DE MATERIALES OPCIONES DE MATERIALES / MATERIAL OPTIONS

**PREFABRICAT DE GRA DE MARBRE**  
PREFABRICADO DE GRANITO DE MÁRMOL  
PRECAST GRANITE MARBLE



**Negre**  
Negro  
Black



**Blanc**  
Blanco  
White

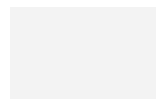

**Color 250**  
Color 250  
Color 250

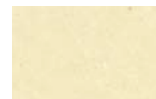

**Beix**  
Beige  
Fawn

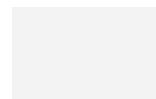

**COLOR CAMPANA** COLOR CAMPANA / HOOD COLOUR



**Gris**  
Gris  
Gray

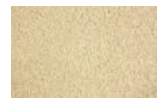

**Beix**  
Beige  
Fawn

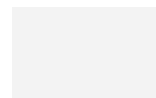
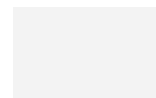
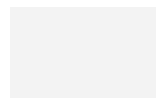

## COMPLEMENTS COMPLEMENTOS / ACCESSORIES



Ref. 110



Ref. 130



Ref. 150



Ref. 160



Ref. 190

Ref. pàg.75

Argemí



# BERGUEDÀ

- Campana de formigó refractari pintada i estucada en blanc.
- Sistema mata guspires.
- Interior de totxo i formigó refractari de 5 cm.
- Tres posicions per a la graella d'acer inoxidable de 69x44 cm.
- Calaix per recollir les cendres independent.
- Taules laterals i pica de gres natural amb perfil en gra de marbre blanc.
- Suport en gra de marbre color blanc amb amplis llenyers.

- Campana en hormigón refractario pintada y estucada en blanco.
- Sistema salva chispas.
- Interior en ladrillo y hormigón refractario de 5 cm.
- Tres posiciones para la parrilla de acero inoxidable de 69x44 cm.
- Cajón para recoger las cenizas independiente.
- Mesas laterales y pila de gres natural con perfil en grano de mármol blanco.
- Soporte en grano de mármol blanco con amplios leñeros.

- *Refractory concrete Hood painted and stuccoed in white.*
- *Anti-spark system.*
- *Refractory brick and concrete interior 5 cm.*
- *Three positions for stainless steel grill 69x44 cm.*
- *Independent ash drawer.*
- *Stoneware and white marble grain side tables and sink.*
- *White marble grain support with wide woodsheds.*

## OPCIONES OPCIONES / OPTIONS



**Reversible**  
Reversible  
Reversible



**Graella 82 cm**  
Parrilla 81 cm  
Grill 82 cm



**Taula auxiliar**  
Mesa auxiliar  
Auxiliar table



**Portes**  
Puertas  
Doors

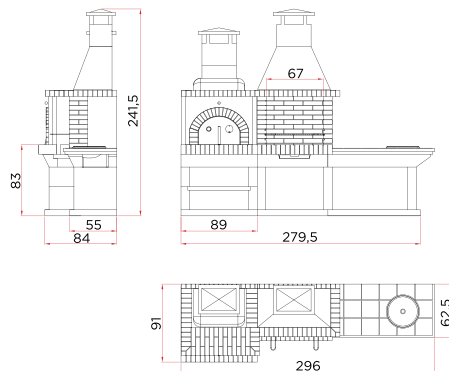

## OPCIONES DE MATERIALES OPCIONES DE MATERIALES / MATERIAL OPTIONS

**PREFABRICAT DE GRA DE MARBRE**  
PREFABRICADO DE GRANITO DE MÁRMOL  
PRECAST GRANITE MARBLE



**Negre**  
Negro  
Black



**Marró**  
Marrón  
Brown

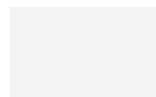

**Color 250**  
Color 250  
Color 250



**Beix**  
Beige  
Fawn

**COLOR CAMPANA** COLOR CAMPANA / HOOD COLOUR



**Gris**  
Gris  
Gray



**Beix**  
Beige  
Fawn

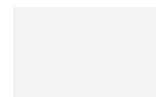
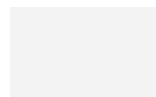

**MARBRE** MÁRMOL / MARBLE

## COMPLEMENTS COMPLEMENTOS / ACCESSORIES

Ref. pàg.75



Ref. 110



Ref. 130



Ref. 150



Ref. 160



Ref. 190

Argemí



# SEGARRA

- Campana de formigó refractari pintada i estucada en blanc.
- Sistema mata guspires.
- Interior de totxo i formigó refractari de 5 cm.
- Tres posicions per a la graella d'acer inoxidable de 69x44 cm
- Taulell i taula lateral en granit negre intens.
- Suport en gra de marbre blanc amb prestatges intermedis en granit negre intens.

- Campana en hormigón refractario pintada y estucada en blanco.
- Sistema salva chispas.
- Interior en ladrillo y hormigón refractario de 5 cm.
- Tres posiciones para la parrilla de acero inoxidable de 69x44 cm.
- Encimera y mesa lateral en granit negre intens.
- Soporte en grano de mármol blanco con estantes intermedios en granito negro intenso.

- *Refractory concrete Hood painted and stuccoed in white.*
- *Anti-spark system.*
- *Refractory brick and concrete interior 5 cm.*
- *Three positions for stainless steel grill 69x44 cm.*
- *Worktop and side table in deep black granite.*
- *White marble grain support with shelves in deep black granite.*

## OPCIONES OPCIONES / OPTIONS



**Reversible**  
Reversible  
Reversible



**Graella 82 cm**  
Parrilla 81 cm  
Grill 82 cm



**Taula auxiliar**  
Mesa auxiliar  
Auxiliar table



**Pica**  
Pila  
Sink

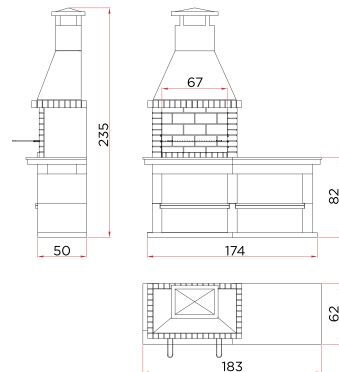

## OPCIONES DE MATERIALS OPCIONES DE MATERIALES / MATERIAL OPTIONS

### PREFABRICAT DE GRA DE MARBRE

PREFABRICADO DE GRANITO DE MÁRMOL  
PRECAST GRANITE MARBLE



**Negre**  
Negro  
Black



**Marró**  
Marrón  
Brown

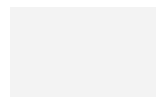

**Color 250**  
Color 250  
Color 250

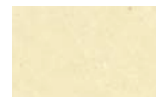

**Beix**  
Beige  
Fawn

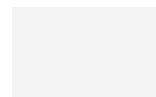

### COLOR CAMPANA COLOR CAMPANA / HOOD COLOUR



**Gris**  
Gris  
Gray



**Beix**  
Beige  
Fawn

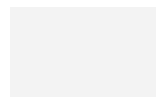

### MARBRE MÁRMOL / MARBLE



**Cenia envellit**  
Cenia envejecido  
Distressed Cenia



**Granit negre intens**  
Granito negro intenso  
Deep black granit

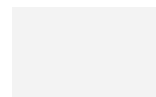

## COMPLEMENTS COMPLEMENTOS / ACCESSORIES

Ref. pàg.75



Ref. 110



Ref. 130



Ref. 150



Ref. 160



Ref. 170



Ref. 190

Argemí



# MANAUS

- Campana de formigó refractari sense pintar.
- Sistema mataguspires.
- Interior de totxo i formigó refractari de 5 cm.
- Graella d'acer inox de 69x45 cm, tres posicions.
- Calaix de cendres independent.
- Revestiment exterior de formigó sense pintar.

- Campana de hormigón refractario sin pintar.
- Sistema matachispas.
- Interior de ladrillo y hormigón refractario de 5 cm.
- Parrilla de acero inox de 69x45 cm, tres posiciones.
- Cajón de cenizas independiente.
- Revestimiento exterior de hormigón sin pintar.

- *Unpainted refractory concrete hood.*
- *Anti-spark sytem.*
- *Refractory brick and concrete interior 5 cm.*
- *Stainless steel grill of 69x45cm, with three positions.*
- *Independent ash drawer.*
- *Unpainted exterior lining in concrete.*



## OPCIONES OPCIONES / OPTIONS



**Graella 82 cm**  
Parrilla 82 cm  
Grill 82 cm

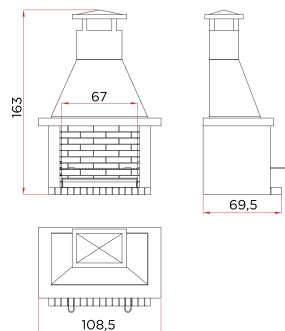

## OPCIONES DE MATERIALS OPCIONES DE MATERIALES / MATERIAL OPTIONS

**PREFABRICAT DE GRA DE MARBRE**  
PREFABRICADO DE GRANITO DE MÁRMOL  
PRECAST GRANITE MARBLE



**Negre**  
Negro  
Black



**Marró**  
Marrón  
Brown



**Blanc**  
Blanco  
White



**Color 250**  
Color 250  
Color 250

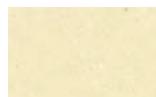

**Beix**  
Beige  
Fawn

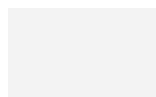

**COLOR CAMPANA** COLOR CAMPANA / HOOD COLOU



**Gris**  
Gris  
Gray



**Beige**  
Beige  
Fawn



**Blanc**  
Blanco  
White

**MARBRE MÁRMOL / MARBLE**

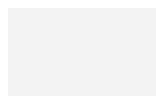
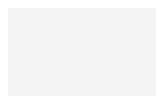
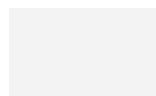

## COMPLEMENTS COMPLEMENTOS / ACCESSORIES



Ref. 110



Ref. 130



Ref. 150



Ref. 160



Ref. 190

Ref. pàg.75

# QUITO

- Interior de totxo i formigó refractari de 5 cm.
- Graella d'acer inox de 69x45 cm, 3 posicions.
- Calaix de cendres independent.
- Sortida de fums amb registre metàl·lic.

- Interior de ladrillo y hormigón refractario de 5 cm.
- Parrilla de acero inox de 69x45 cm, 3 posiciones.
- Cajón de cenizas independiente.
- Salida de humos con registro metálico.

- *Refractory brick and concrete interior 5 cm.*
- *Stainless steel grill of 69x45 cm, with 3 positions.*
- *Independent ash drawer.*
- *Metal register smoke output.*

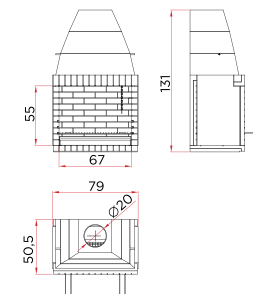

## OPCIONES OPCIONES / OPTIONS



**Graella 82 cm**  
Parrilla 82 cm  
Grill 82 cm

## COMPLEMENTS

COMPLEMENTOS  
ACCESSORIES

Ref. pàg.75



Ref. 110



Ref. 130



Ref. 150



Ref. 160



# FORN

- Interior de totxo i formigó refractari.
- Porta metàl·lica amb espell i termòmetre de barra.
- Sortida de fums de formigó refractari.
- Registre d'acer inoxidable.

- Interior de ladrillo y hormigón refractario.
- Puerta metálica con mirilla y termómetro de barra.
- Salida de humos de hormigón refractario.
- Registro de acero inoxidable.

- *Refractory brick and concrete interior.*
- *Metal door with peephole and bar thermometer.*
- *Refractory concrete smoke output.*
- *Stainless steel register.*

## OPCIONES

OPCIONES  
OPTIONS



**Extensió 32 cm**  
Extensión 32 cm  
Extension 32 cm

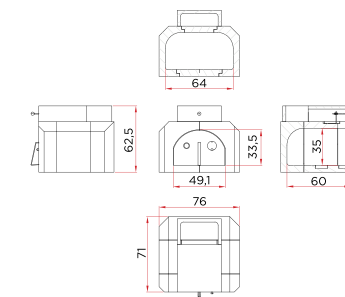

# MALLORCA

BANCADA | MESA | TABLE

- Suport i taules laterals de formigó gris i granit negre intens.
- Soporte y mesas laterales en hormigón gris y granito negro intenso.
- *Support and side benches in gray concrete and deep black granite.*

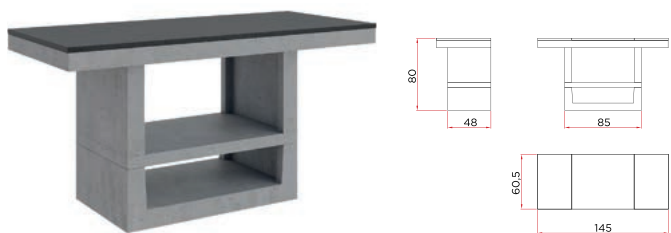

## OPCIONES OPCIONES / OPTIONS

 **Taula auxiliar**  
Mesa auxiliar  
*Auxiliar table*

## OPCIONES DE MATERIALES

OPCIONES DE MATERIALES  
*MATERIAL OPTIONS*

**PREFABRICAT DE CIMENT**  
PREFABRICADO DE CEMENTO  
*PRECAST CONCRETE*

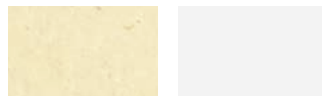

**Beix**  
Beige  
*Fawn*

**MARBRE MÁRMOL / MARBLE**

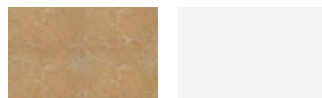

**Cenia envellit**  
Cenia envejecido  
*Distressed Cenia*

## COMPLEMENTOS

COMPLEMENTOS  
*ACCESSORIES*

Ref. pàg.75



Ref. 150

# MALLORCA LD/LI

BANCADA | MESA | TABLE

- Suport i taules laterals de formigó gris i granit negre intens.
- Soporte y mesas laterales en hormigón gris y granito negro intenso.
- *Support and side benches in gray concrete and deep black granite.*



## OPCIONES OPCIONES / OPTIONS

 **Reversible**  
Reversible  
*Reversible*

 **Taula auxiliar**  
Mesa auxiliar  
*Auxiliar table*

## COMPLEMENTOS

COMPLEMENTOS  
*ACCESSORIES*

Ref. pàg.75



Ref. 150

## OPCIONES DE MATERIALES

OPCIONES DE MATERIALES  
*MATERIAL OPTIONS*

**PREFABRICAT DE CIMENT**  
PREFABRICADO DE CEMENTO  
*PRECAST CONCRETE*

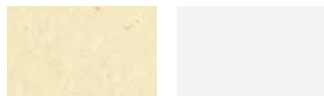

**Beix**  
Beige  
*Fawn*

**MARBRE MÁRMOL / MARBLE**

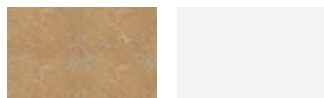

**Cenia envellit**  
Cenia envejecido  
*Distressed Cenia*

# COMPLEMENTOS

COMPLEMENTOS / ACCESSORIES

Ref.



**110**  
**Graella recollidora de greixos**  
Parrilla recogedora de grasa  
*Grease collector grill*



**130**  
**Planxa de cocció inox**  
Plancha de cocción inox  
*Stainless steel griddle*



**150**  
**Llosa pedra**  
Losa piedra  
*Stone slab*



**160**  
**Trespeus**  
Trébede  
*Tripod*



**170**  
**Calaix de cendres independent**  
Cajón de cenizas independiente  
*Independent ash drawer*



**190**  
**Allargament de campana**  
Alargo de campana  
*Hood extension*

Notes legals / Notas legales / Legal notes

Prohibida la reproducció, per qualsevol mitjà, total o parcial, de qualsevol dels continguts i imatges d'aquest catàleg. Els colors dels productes i acabats reproduïts en el present catàleg estan subjectes a les variacions pròpies de la reproducció gràfica. Argemí Prefabricats SL es reserva el dret a variar el disseny dels seus productes i acabats.

Prohibida la reproducción, por cualquier medio, total o parcial, de cualquiera de los contenidos e imágenes de este catálogo. Los colores de los productos y acabados reproducidos en el presente catálogo están sujetos a las variaciones propias de la reproducción gráfica. Argemí Prefabricats SL se reserva el derecho a variar el diseño de sus productos y acabados.

*The reproduction, by any method, total or partial, of any of the contents and images of this catalogue is prohibited. The colours of the products and finishes reproduced in this catalogue are subject to the variations of the graphic reproduction. Argemí Prefabricats SL reserves the right to vary the design of its products and finishes.*

# Argemí®

LLARS DE FOC  
BARBACOES  
BIOMASSA



+34 93 881 20 25

+34 689 46 33 33

[www.argemiprefabricats.com](http://www.argemiprefabricats.com)